

# Industrial Computers and Monitors Specifications

Bulletin Numbers 6177R, 6181P, 6181X, 6176M, 6186M, 6189V, 6200M, 6200P, 6200T

Integrated Display and Non-display Computers (6181P)



Integrated Display and Non-display Computers for Hazardous Locations (6181X)



Industrial Keyboard and Pointing Device Accessories (6189V)



VersaView Thin Clients and Industrial Computers (5200, 5400)



VersaView Industrial Monitors (5100)

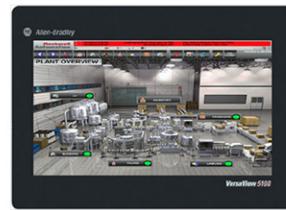

Non-display Computers (6177R)



Performance Industrial Monitors (6186M)



Standard Industrial Monitors (6176M)



Topic	Page
Summary of Changes	2
Overview	2
Rockwell Automation Industrial Computers	5
• VersaView 5200 Thin Clients and 5400 Industrial Computers	5
• 6181P Integrated Display and Non-display Computers	12
• 6181X Integrated Display and Non-display Computers for Hazardous Locations	18
• 6177R Non-display Computers	22
• 6189V Industrial Keyboard and Pointing Device Accessories	26
Rockwell Automation Industrial Monitors	27
• VersaView 5100 Industrial Monitors	28
• 6186M Performance Industrial Monitors	31
• 6176M Standard Industrial Monitors	34
HMI Software	38
Software Comparison	40
Additional Resources	43



## Summary of Changes

This publication contains new and updated information as indicated in the following table.

Topic	Page
Added Cat. No. suffix -NAK to a table cell.	3, 5, 6
Added the two bullet points to table footnote 2.	3
Added Cat. No. 6181X-12P2SWX1DC to the available touch screens row of the 6181X table column, and table footnote 6.	4
Added INMETRO to the Special Requirements row of the 6181X column in Table 2.	4
Added paragraph about VersaView® 5000 devices for hazardous locations.	5
Added Hazardous Locations paragraph and table to VersaView section.	6
Added Cat. Nos. 6200P-NS3x1K, 6200P-NS3C6, and 6200-NAK to column headings in the Input Power Specifications table.	7
Added Cat. No. 6200-NAK to a column heading in the VersaView 5200 Technical Specifications table.	8
Added footnote 3 to the VersaView 5400 Technical Specifications table.	9
Added Cat. Nos. Cat. Nos. 6200T-NAK, 6200P-NS3x1K, and 6200P-NS3C6 to a figure title, and the Important table.	10
Added pictures of integrated display with PCAP touch screen, and sun shield attached to an integrated display computer.	18
Added paragraph about the available sun shield.	18
Updated enclosure ratings row of 6181X Environmental Specifications table.	18
Added column heading for Cat. No. 6181X-12P2SWX1DC to 6181X Technical Specifications table.	21
Added footnotes 2 and 3 to the 6181X Technical Specifications table.	21
Added touch screen callouts, and callout D to the illustration and table for 6181X Dimensions section.	22
Added 6189V Industrial Keyboard and Pointing Device Accessories picture and table.	26
Revised introductory paragraph and added second paragraph to 6186M performance monitors section.	31
Added 'for use in hazardous locations' to c-UL-us certification row in 6186M certifications table.	35

## Overview

This document provides technical specifications, environmental specifications, certifications, and dimension drawings for the Allen-Bradley® portfolio of industrial computers and monitors from Rockwell Automation.

Use this document with the Visualization Solutions Selection Guide, publication [VIEW-SG001](#), to make initial decisions on the visualization products that are best suited for your system requirements.

## Rockwell Automation Industrial Computers

Rockwell Automation industrial environment computers offer solutions for the physical limitations and requirements of your environment. Non-display computers provide a variety of options in form factors, RAM, storage, performance, operating temperatures and optical drives. Integrated display computers are available in different screen sizes, storage options, and performance packages.

Our extreme environment computers combine Hazardous Location certifications with the capacity to withstand more extreme temperatures. Industries such as oil and gas, chemicals, and mining involve potentially explosive materials in locations where hardware often takes a beating. These computers are designed to endure harsh temperature extremes and are IECEx, ATEX, and UL rated for hazardous locations.

To help with your purchase, [Table 1](#) on [page 3](#) and [Table 2](#) on [page 4](#) compare the various industrial computer features.

**Table 1 - VersaView® 5200 and 5400 Thin Client and Industrial Computers Comparison**

Attribute	VersaView 5400 Integrated Display Industrial Computer	VersaView 5400 Non-display Industrial Computer	VersaView 5200 Integrated Display Thin Client	VersaView 5200 Non-display Thin Client
Available display sizes/resolution	<ul style="list-style-type: none"> <li>12.1 in./1280 x 800</li> <li>15.6 in./1366 x 768</li> <li>18.5 in./1366 x 768</li> <li>21.5 in./1920 x 1080</li> </ul>	Non-display (NDM)	<ul style="list-style-type: none"> <li>12.1 in./1280 x 800</li> <li>15.6 in./1366 x 768</li> <li>18.5 in./1366 x 768</li> <li>21.5 in./1920 x 1080</li> </ul>	Non-display (NDM)
Available touch screens	PCAP multi-touch	—	PCAP multi-touch	—
External video connections	1 x DisplayPort	<ul style="list-style-type: none"> <li>1 x DisplayPort</li> <li>1 x VGA</li> </ul>	1 x DisplayPort	<ul style="list-style-type: none"> <li>DisplayPort<sup>(2)</sup></li> <li>VGA<sup>(3)</sup></li> <li>HDMI<sup>(4)</sup></li> </ul>
Keypad	None			
Display bezel	Glass and aluminum	—	Glass and aluminum	—
Package options	Standard			
Available processors	Intel quad-core Atom E3845, 1.91 GHz		See <a href="#">page 8</a> .	
Primary storage media	128 GB multi-level cell, solid-state drive (MLC SSD)		None	
RAM <ul style="list-style-type: none"> <li>Type</li> <li>Supplied/max (GB)</li> </ul>	DDR3, SO-DIMM 4/4	DDR3 4/4	DDR3, SO-DIMM 2/2	DDR3 1/1, 2/2, or 4/4 <sup>(5)</sup>
Expansion slots	None			
Available removable media	Secure digital (SD™) card slot	None	SD card slot	None
I/O connectors	9; see <a href="#">page 8</a> .			
Available Windows operating systems	<ul style="list-style-type: none"> <li>7 Pro SP1 32 bit/64 bit<sup>(1)</sup></li> <li>WES 7 32 bit/64 bit<sup>(1)</sup></li> <li>10 IoT Enterprise 64 bit</li> </ul>		ThinManager® ready	
CompactFlash quantity	None			
Power	24V DC	12...24V DC	24V DC	<ul style="list-style-type: none"> <li>6200T-BA: 120...240V AC, 5V DC<sup>(6)</sup></li> <li>6200T-NA, -NAK: 12...24V DC</li> <li>6200T-KB, -RC, -RE: 24V DC</li> </ul>
Special requirements	None			
Mount options	<ul style="list-style-type: none"> <li>Panel (display models)</li> <li>VESA®</li> </ul>	<ul style="list-style-type: none"> <li>Vertical</li> <li>DIN rail</li> <li>VESA</li> <li>Legacy 6155R</li> <li>Machine</li> </ul>	<ul style="list-style-type: none"> <li>Panel (display models)</li> <li>VESA</li> </ul>	<ul style="list-style-type: none"> <li>Vertical</li> <li>DIN rail</li> <li>VESA</li> <li>Legacy 6155R</li> <li>Machine</li> </ul>

(1) 32-bit images for these Windows operating systems are available from the Rockwell Automation Product Compatibility and Download Center (PCDC) website at <https://compatibility.rockwellautomation.com/Pages/home.aspx>.

(2) All Thin Client models have one DisplayPort except for the following:

- Cat. No. 6200T-RC has three full-sized DisplayPorts
- Cat. No. 6200T-RE has three full-sized DisplayPorts and four mini-DisplayPorts

(3) Only Thin Client Cat. Nos. 6200T-NA and 6200T-NAK have a VGA port.

(4) Only Thin Client Cat. No. 6200T-KB has a HDMI port.

(5) The following memory is supplied/max: 1/1 GB for Cat. Nos. 6200T-NA and 6200T-NAK, 2/2 GB for Cat. No. 6200T-BA, and 4/4 GB for Cat. Nos. 6200T-KB, 6200T-RC, and 6200T-RE.

(6) You must use the 100...240V AC, 50...60 Hz, 1.2 A input, 5V DC, 4 A power supply with barrel connector that is supplied with this Thin Client model.

**Table 2 - 6181P, 6181X, and 6177R Industrial Computers Comparison**

Attribute	<b>6181P Integrated Display Industrial Computer (NDM, 1200P, 1500P, 1700P, and 1900P)</b>	<b>6181X Industrial Computer for Hazardous Locations (1200XT)</b>	<b>6177R Non-display Computer (750R &amp; 1450R)</b>
Available display sizes/resolution	<ul style="list-style-type: none"> <li>Non-display option (NDM)</li> <li>12.1 in./1024 x 768</li> <li>15 in.<sup>(2)</sup>/1024 x 768 or 1366 x 768</li> <li>17 in./1280 x 1024</li> <li>19 in.<sup>(2)</sup>/1280 x 1024 or 1366 x 768</li> </ul>	<ul style="list-style-type: none"> <li>NDM</li> <li>12.1 in./1024 x 768</li> </ul>	Requires external monitor
Available touch screens	Performance: Resistive Advanced: PCAP <sup>(2)</sup>	<ul style="list-style-type: none"> <li>Resistive, sunlight readable</li> <li>PCAP, sunlight readable<sup>(6)</sup></li> </ul>	None
Keypad	None	None	None
Display bezel	Aluminum or stainless steel	Aluminum	None
Package options <sup>(1)</sup>	Performance or Advanced	Performance	Performance, Advanced, or Server
Available processors	Performance: Intel® Core™ i3-4102E Advanced: Intel Core i7-4700EQ	Intel Core i3-5010U	Intel Core i3-2120 or Intel Core i5-2400
Primary storage media			<ul style="list-style-type: none"> <li>500 GB, 3.5-in. SATA<sup>(8)</sup></li> <li>1 TB, 3.5-in. SATA<sup>(9)</sup></li> </ul>
• Hard disk drive (HDD)			
• Solid-state drive (SSD)	32 GB SLC, 2.5-in. SATA or 256 GB MLC, 2.5-in.	128 GB MLC, 2.5-in. <sup>(7)</sup>	
RAM memory type (GB installed/max)	Performance: DDR3 (4/16) Advanced: DDR3 (8/16)	DDR3 (8/16)	DDR3 (4 or 8/32)
Expansion slots	1 half-length PCI Express x8 <sup>(3)</sup>	1 half-length PCIe x1	<ul style="list-style-type: none"> <li>1 or 4 PCI</li> <li>1 PCI Express x16</li> <li>1 PCI Express x4</li> <li>1 PCI Express x1</li> </ul>
Available removable media	<ul style="list-style-type: none"> <li>CompactFlash</li> <li>Performance: None supplied, but can be added via the 6189V-ODD kit</li> <li>Advanced: DVD-RW/CD-RW</li> </ul>	CompactFlash	DVD-RW optical disk drive (ODD)
I/O connectors	Up to 16; see pages <a href="#">15</a> and <a href="#">16</a> .	10; see page <a href="#">21</a> .	9; see page <a href="#">24</a> .
Available Windows operating systems	<ul style="list-style-type: none"> <li>10 IoT Enterprise (64 bit)</li> <li>7 Professional (64 bit) SP1</li> <li>Embedded Standard 2009</li> <li>Embedded Standard 7 (64 bit) SP1</li> <li>Server 2008 R2 (64 bit) SP1<sup>(4)</sup></li> </ul>	<ul style="list-style-type: none"> <li>10 IoT Enterprise (64 bit)</li> <li>7 Professional (64 bit) SP1</li> </ul>	<ul style="list-style-type: none"> <li>10 IoT Enterprise (64 bit)</li> <li>8.1 Industry Pro (64 bit)</li> <li>7 Professional (64 bit) SP1</li> <li>Server 2012 R2 (64 bit)</li> <li>Server 2008 R2 (64 bit) SP1</li> </ul>
CompactFlash quantity/type	1/Type II	1/Type II	None
Power	AC or DC	DC	AC
Special requirements	Model dependent: 0...55 °C (32...131 °F) or 0...50 °C (32...122 °F)	<ul style="list-style-type: none"> <li>Rated to 70 °C (158 °F) for c-UL-us hazardous, ATEX, INMETRO, and IECEx locations</li> <li>Preferred monitor: 6186M hazardous location monitor</li> </ul>	0...50 °C (32...122 °F)
Mount options	<ul style="list-style-type: none"> <li>Panel mount (display models)</li> <li>Wall (non-display models)</li> <li>Table<sup>(5)</sup></li> <li>Bookshelf<sup>(3)</sup></li> <li>Machine<sup>(3)</sup></li> </ul>	<ul style="list-style-type: none"> <li>Panel mount (display models)</li> <li>Wall (non-display models)</li> </ul>	750R: machine mount 1450R: 4U rack mount

(1) Package option determines processor type, amount of RAM, type of removable media, number of external connectors or I/O, and type of expansion slots.

(2) Some Advanced models are also available in widescreen formats (16:9 aspect ratio), which have projective capacitive (PCAP) touch screens.

(3) Upgradeable to 1 PCI, 2 PCI, 2 PCIe x4, or 1 PCIe x4 + 1 PCI with separate PCI riser kits.

(4) Cat. Nos. 6181P-00N3MS81DC and 6181P-00N3MS81AC ship with this Windows operating system, which are the only two models meant for RAID configuration.

(5) Applies only to series F NDM models. The bookshelf mount requires a bracket (Cat. No. 6189V-BOOKBRKT), which is sold separately.

(6) PCAP touch screen applies only to Cat. No. 6181X-12P2SWX1DC.

(7) Upgradeable to 256 GB MLC SSD (Cat. No. 6189X-256GBSSD).

(8) RAID 1 enabled server models ship with two 500 GB HDDs.

(9) Available only as an accessory (Cat. No. 6189V-35HDD1TB).

## VersaView 5200 Thin Clients and 5400 Industrial Computers

The Allen-Bradley VersaView 5000 portfolio is a line of industrial computers and thin clients that can be used for standalone machine-level and distributed HMI applications. The open architecture supports modern operating systems and various software applications, including FactoryTalk® View SE software for distributed applications. The line is fanless and lowers maintenance cost to reduce costly machine downtime.

The VersaView 5400 integrated display computers have an edge-to-edge, all glass, ten-point multi-touch screen that can also be operated with gloves. The touch screens are precalibrated so that recalibration is not necessary.

All VersaView non-display computers perform the same as the integrated display computers, in a compact design that supports multiple mounting options.

The VersaView 5200 ThinManager® Thin Clients work exclusively with ThinManager software for centrally-managed content delivery. Integrated display and non-display versions are available.

Some of the VersaView 5400 industrial computers and the dual display VersaView 5200 Thin Client can be used in harsh locations found in the oil and gas, tire and rubber, and pulp and paper industries. Some models are also available with conformal coating, which helps protect product circuitry from environmental stresses like moisture, fungus, dust, and corrosion. See [Table 4](#) on [page 6](#) for the VersaView 5000 models available for hazardous locations.

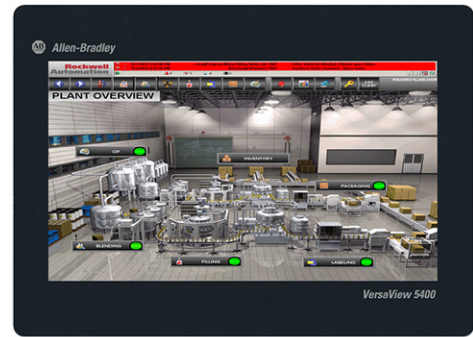

VersaView 5400 Industrial Display and Non-display Computers



VersaView 5200 Thin Clients



**Table 3 - Environmental Specifications, VersaView 5200 Thin Clients and 5400 Industrial Computers**

Attribute	5200 Display Thin Clients	5400 Display Industrial Computers	5200 Non-display Thin Clients	5400 Non-display Industrial Computers
Temperature, operating	0...50 °C (32...122 °F)		<ul style="list-style-type: none"> <li>6200T-BA: 0...50 °C (32...122 °F)</li> <li>6200T-KB: 0...55 °C (32...131 °F)</li> <li>6200T-NA, -NAK: -20...+60 °C (-4...+140 °F)</li> <li>6200T-RC, -RE: 0...45 °C (32...113 °F)</li> </ul>	-20...+60 °C (-4...+140 °F)
Temperature, nonoperating	-20...+60 °C (-4...+140 °F)			
Relative humidity	10...90% noncondensing			
Shock, operating	15 g (1/2 sine, 11 ms)			
Shock, nonoperating	30 g (1/2 sine, 11 ms)			
Vibration, operating and nonoperating	0.012 in. p-p, 10...57 Hz, 2 g peak, 57...640 Hz			
Altitude, operating	Sea level to 3,000 m (9842 ft)		Sea level to 2000 m (6562 ft)	
Altitude, nonoperating	Sea level to 4572 m (15,000 ft)		Sea level to 10,000 m (32,810 ft)	
Enclosure ratings	IEC 60529, IP65		IP20	

The following table applies only to the VersaView 5000 thin client and industrial computers for hazardous locations. The pertinent catalog numbers are listed in the table.

**Table 4 - Hazardous Location Ratings by Region, VersaView 5000 Hazardous Location Thin Clients and Industrial Computers**

Cat. Nos. <sup>(1)(2)</sup>		Region	Rating	Temperature Range
5200 Thin Client Non-display Models	5400 Industrial Computer Non-display Models			
6200T-NA, 6200T-NAK	6200P-NS3A1, 6200P-NS3A1K, 6200P-NS3B1, 6200P-NS3B1K, 6200P-NS3C1, 6200P-NS3C1K, 6200P-NS3C6	United States	Class I Division 2, Groups A, B, C, D T4 Class I Zone 2, IIC, T4	-20 °C ≤ T <sub>a</sub> ≤ +60 °C <sup>(3)</sup> (-4 °F ≤ T <sub>a</sub> ≤ +140 °F)
		Canada	Class I Division 2, Groups A, B, C, D T4 Class I Zone 2, IIC, T4	
		Europe (ATEX)	 II 3 G, Ex ec IIC T4 Gc, DEMKO 19 ATEX 2252 X	

**(1) Conditions for Safe Use**

The following applies to VersaView 5000 thin client and industrial computers for hazardous locations:

- The equipment shall only be used in an area of not more than Pollution Degree 2, as defined in EN 60664-1.
- The equipment shall be installed in a tool-only accessible enclosure that provides a degree of protection not less than IP54 in accordance with EN 60079-0.
- Transient protection shall be provided that is set at a level not exceeding 140% of the peak rated voltage value at the supply terminals to the equipment.
- The internal enclosure ambient temperature range is -20...+60 °C (-4...+140 °F).

(2) VersaView Cat. Nos. with a K suffix (for example, 6200T-NAK) designate models with conformal coating.

(3) These ThinManager thin client and industrial computers for hazardous locations are required to be mounted in a restricted access location.

**Table 5 - Power Specifications, VersaView 5200 Thin Client Models**

Customer Loading	Attribute	5200 Thin Client Non-display Models (6200T-xx)					5200 Thin Client Display Models			
		-BA	-KB	-NA, -NAK	-RC	-RE	12.1 in.	15.6 in.	18.5 in.	21.5 in.
Typical <sup>(1)</sup>	Input power, (W) <sup>(3)</sup>	3.9	11.3	4.5	29.5	43.7	24.5	23.8	24.2	34
	Heat dissipation, (BTU/hr)	13.3	38.5	15.3	100.6	146.7	83.6	81.2	82.6	126.2
Maximum <sup>(2)</sup>	Input power, (W) <sup>(3)</sup>	6.9	22	4.9	35	80.9	36.7	35.3	35.8	45.4
	Heat dissipation, (BTU/hr)	23.5	75	16.7	119.4	276	125.2	120.4	122.1	155

(1) Typical load is defined as the system is running Passmark Burn-in at 30% load with USB mouse and USB loop-backs, VGA and DisplayPort used, and both Ethernet ports being used.

(2) Maximum load is defined as the system is running Passmark Burn-in at 100% load with USB mouse, USB dummy loads, VGA and DisplayPort used, and both Ethernet ports being used.

(3) Input voltage is 24V DC except for 6200T-BA, which is 100...240V AC, 1.2A input. Wattage values are measurements, and can differ from maximum ratings required by UL.

**Table 6 - Power Specifications, VersaView 5400 Industrial Computer Models**

Customer Loading	Attribute	5400 Industrial Computer Models				
		Non-display	12.1 in.	15.6 in.	18.5 in.	21.5 in.
Typical <sup>(1)</sup>	Input power, (W) <sup>(3)</sup>	12.8	24.5	23.8	24.2	34
	Heat dissipation, (BTU/hr)	43.9	83.6	81.2	82.6	126.2
Maximum <sup>(2)</sup>	Input power, (W) <sup>(3)</sup>	19.7	36.7	35.3	35.8	45.4
	Heat dissipation, (BTU/hr)	67.2	125.2	120.4	122.1	155

(1) Typical load is defined as the system is running Passmark Burn-in at 30% load with USB mouse and USB loop-backs, VGA and DisplayPort used, and both Ethernet ports being used.

(2) Maximum load is defined as the system is running Passmark Burn-in at 100% load with USB mouse, USB dummy loads, VGA and DisplayPort used, and both Ethernet ports being used.

(3) Input voltage is 24V DC except the non-display model (NDM), which is 12...24V DC. Wattage values are measurements, and can differ from maximum ratings required by UL.

**Table 7 - Input Power Specifications, VersaView 5200 Thin Client and 5400 Industrial Computer Models**

Attribute	VersaView Non-display Models						VersaView Display Models			
	6200P-NS3x1, 6200P-NS3x1K, 6200P-NS3C6	6200T-BA <sup>(1)</sup>	6200T-KB	6200T-NA, 6200T-NAK	6200T-RC	6200T-RE	12.1 in.	15.6 in.	18.5 in.	21.5 in.
Input voltage	12...24V DC	5V DC	24V DC	12...24V DC	24V DC		24V DC			
Input power, max	4.25...2.125 A SELV	2.2 A SELV	1.25 A SELV	4.25...2.125 A SELV	2.8 A SELV	3.4 A SELV	3 A SELV/LPS		3.5 A SELV/LPS	

(1) You must use the 100...240V AC, 50...60 Hz, 1.2 A input, 5V DC, 4 A power supply with barrel connector that is supplied with this Thin Client model.

**Table 8 - Certifications, VersaView 5200 and 5400 Computers**

For the most current certification information, visit the Rockwell Automation Literature Library website at <https://www.rockwellautomation.com/global/literature-library/overview.page>. Use 6200-CT as your search criteria.

Certification	All VersaView Models																																																																					
c-UL-us	For details, see <a href="#">6200-CT003</a> and <a href="#">6200-CT011</a> .																																																																					
CE	For details, see <a href="#">6200-CT002</a> and <a href="#">6200-CT009</a> .																																																																					
EAC	For details, see <a href="#">6200-CT005</a> .																																																																					
FCC	Class A emissions																																																																					
KC	For details, see <a href="#">6200-CT001</a> and <a href="#">6200-CT012</a> .																																																																					
RCM	For details, see <a href="#">6200-CT004</a> and <a href="#">6200-CT010</a> .																																																																					
RoHS	<p>European RoHS 2011/65/EU. For more details, see <a href="#">6200-CT002</a>.</p> <p>China RoHS:</p> <table border="1"> <thead> <tr> <th rowspan="2">部件名称 Part Name</th> <th colspan="6">有毒有害物质或元素 Toxic or Hazardous Substances and Elements</th> </tr> <tr> <th>铅 Lead (Pb)</th> <th>汞 Mercury (Hg)</th> <th>镉 Cadmium (Cd)</th> <th>六价铬 Hexavalent Chromium (Cr(VI))</th> <th>多溴联苯 Polybrominated Biphenyls (PBB)</th> <th>多溴二苯醚 Polybrominated Diphenyl Ethers (PBDE)</th> </tr> </thead> <tbody> <tr> <td>壳体 Housing</td> <td>X</td> <td>0</td> <td>0</td> <td>0</td> <td>0</td> <td>0</td> </tr> <tr> <td>显示 Display</td> <td>X</td> <td>0</td> <td>0</td> <td>0</td> <td>0</td> <td>0</td> </tr> <tr> <td>印刷电路板 Printed Circuit Board</td> <td>X</td> <td>0</td> <td>0</td> <td>0</td> <td>0</td> <td>0</td> </tr> <tr> <td>金属螺帽 Metal Fasteners</td> <td>X</td> <td>0</td> <td>0</td> <td>0</td> <td>0</td> <td>0</td> </tr> <tr> <td>电缆组装 Cable Assembly</td> <td>X</td> <td>0</td> <td>0</td> <td>0</td> <td>0</td> <td>0</td> </tr> <tr> <td>风扇组装 Fan Assembly</td> <td>X</td> <td>0</td> <td>0</td> <td>0</td> <td>0</td> <td>0</td> </tr> <tr> <td>电力供应组装 Power Supply Assemblies</td> <td>X</td> <td>0</td> <td>0</td> <td>0</td> <td>0</td> <td>0</td> </tr> <tr> <td>电池 Battery</td> <td>0</td> <td>0</td> <td>0</td> <td>0</td> <td>0</td> <td>0</td> </tr> </tbody> </table> <p>本表格依据SJ/T11364 的规定编制。 This table is made per guidance of SJ/T 11364.</p> <p>0: 表示该有害物质在该部件所有均质材料中的含量均在GB/T26572 规定的限量要求以下。 0: Indicates that this toxic or hazardous substance contained in all of the homogeneous materials for the part is below the limit requirement in GB/T 26572.</p> <p>X: 表示该有害物质至少在该部件的某一均质材料中的含量超出GB/T26572 规定的限量要求。 求。(企业可在此处, 根据实际情况对上表中打“X”的技术原因进行进一步说明。) X: Indicates that this toxic or hazardous substance contained in at least one of the homogeneous materials for the part is below the limit requirement in GB/T 26572.</p> <p>Turkey RoHS (EEE Yönetmeliğine Uygundur. In Conformity with the EEE Regulation)</p>	部件名称 Part Name	有毒有害物质或元素 Toxic or Hazardous Substances and Elements						铅 Lead (Pb)	汞 Mercury (Hg)	镉 Cadmium (Cd)	六价铬 Hexavalent Chromium (Cr(VI))	多溴联苯 Polybrominated Biphenyls (PBB)	多溴二苯醚 Polybrominated Diphenyl Ethers (PBDE)	壳体 Housing	X	0	0	0	0	0	显示 Display	X	0	0	0	0	0	印刷电路板 Printed Circuit Board	X	0	0	0	0	0	金属螺帽 Metal Fasteners	X	0	0	0	0	0	电缆组装 Cable Assembly	X	0	0	0	0	0	风扇组装 Fan Assembly	X	0	0	0	0	0	电力供应组装 Power Supply Assemblies	X	0	0	0	0	0	电池 Battery	0	0	0	0	0	0
部件名称 Part Name	有毒有害物质或元素 Toxic or Hazardous Substances and Elements																																																																					
	铅 Lead (Pb)	汞 Mercury (Hg)	镉 Cadmium (Cd)	六价铬 Hexavalent Chromium (Cr(VI))	多溴联苯 Polybrominated Biphenyls (PBB)	多溴二苯醚 Polybrominated Diphenyl Ethers (PBDE)																																																																
壳体 Housing	X	0	0	0	0	0																																																																
显示 Display	X	0	0	0	0	0																																																																
印刷电路板 Printed Circuit Board	X	0	0	0	0	0																																																																
金属螺帽 Metal Fasteners	X	0	0	0	0	0																																																																
电缆组装 Cable Assembly	X	0	0	0	0	0																																																																
风扇组装 Fan Assembly	X	0	0	0	0	0																																																																
电力供应组装 Power Supply Assemblies	X	0	0	0	0	0																																																																
电池 Battery	0	0	0	0	0	0																																																																

**Table 9 - Technical Specifications, VersaView 5200 Thin Client Models**

Attribute	5200 Thin Client Models							
	Non-Display				Display			
	Cat. No. 6200T-BA	Cat. Nos. 6200T-NA, 6200T-NAK	Cat. No. 6200T-KB	Cat. Nos. 6200T-RC, 6200T-RE	12.1 in. Display	15.6 in. Display	18.5 in. Display	21.5 in. Display
Display type	—				Color active-matrix TFT flat panel			
Display size, diagonal	—				12.1 in. (307 mm)	15.6 in. (396 mm)	18.5 in. (470 mm)	21.5 in. (546 mm)
Display aspect ratio	—				16:9			
Display resolution, max	—				1280 x 800	1366 x 768	1366 x 768	1920 x 1080
Response time, ms	—				10	8	5	25
Touch screen	—				PCAP multi-touch			
Bezel	—				Edge-to-edge glass with aluminum ring			
Available processors	Intel Atom® E3815, 1.46 GHz		Intel Atom x7-E3950, 1.60 GHz	Intel Core i5-7500T, 2.70 GHz	Intel Atom E3815, 1.46 GHz			
CPU core	Single		Quad		Single			
RAM • Type • Supplied/max (GB)	DDR3 2/2	DDR3 <sup>(1)</sup> 1/1	DDR3 4/4		DDR3, SO-DIMM 4/4			
Available storage drives	—							
Expansion slots	—							
Available optical storage device	—							
CompactFlash type	—							
SD slot	—				1 full-size SDHC™			
I/O connections	<ul style="list-style-type: none"> <li>1 x USB 3.0 Type A port</li> <li>3 x USB 2.0 Type A ports</li> <li>1 x Ethernet RJ45 LAN port, 1 Gb</li> <li>1 x analog audio output</li> </ul>	<ul style="list-style-type: none"> <li>1 x USB 3.0 Type A port</li> <li>2 x USB 2.0 Type A ports</li> <li>1 x RS-232, DB9 port</li> <li>2 x Ethernet RJ45 LAN ports, 1 Gb each</li> </ul>	<ul style="list-style-type: none"> <li>4 x USB 3.0 Type A port</li> <li>2 x USB 2.0 Type A ports</li> <li>1 x RS-232, DB9 port</li> <li>2 x Ethernet RJ45 LAN ports, 1 Gb each</li> </ul>	<ul style="list-style-type: none"> <li>2 x USB 3.0 Type A port</li> <li>4 x USB 2.0 Type A ports<sup>(2)</sup></li> <li>2 x RS-232, DB9 ports</li> <li>3 x Ethernet RJ45 LAN ports, 1 Gb each</li> <li>1 x analog audio input<sup>(3)</sup></li> <li>1 x analog audio output</li> <li>1 x microphone input<sup>(3)</sup></li> </ul>	<ul style="list-style-type: none"> <li>1 x RS-232, DB9 port</li> <li>2 x Ethernet RJ45 LAN ports, 1 Gb each</li> </ul>			
External video connections/ max resolution	<ul style="list-style-type: none"> <li>1 x DisplayPort/2560 x 1600<sup>(4)</sup></li> </ul>	<ul style="list-style-type: none"> <li>1 x DisplayPort/2560 x 1600<sup>(4)</sup></li> <li>1 x VGA/1920 x 1440</li> </ul>	<ul style="list-style-type: none"> <li>1 x DisplayPort/3840 x 2160<sup>(4)(5)</sup></li> <li>1 x HDMI/3840 x 2160<sup>(4)</sup></li> </ul>	<ul style="list-style-type: none"> <li>3 x full-sized DisplayPort/3840 x 2160<sup>(4)</sup></li> <li>4 x mini-DisplayPort/3840 x 2160<sup>(4)(6)</sup></li> </ul>	1 x DisplayPort/2560 x 1600 <sup>(4)</sup>			
Available operating systems	ThinManager® software ready							
Weight, approx	0.95 kg (2.1 lb)	1.78 kg (3.93 lb)	1.76 kg (3.88 lb)	6200T-RC: 5.22 kg (11.5 lb) 6200T-RE: 4.96 kg (10.93 lb)	5.0 kg (11.02 lb)	5.9 kg (13 lb)	8.3 kg (18.29 lb)	9.5 kg (20.94 lb)
Dimensions, approx	See <a href="#">page 10</a> .				See <a href="#">page 11</a> .			
Cutout dimensions	—				250 x 312 mm (9.84 x 12.28 in.)	282 x 398 mm (11.1 x 15.67 in.)	321 x 464 mm (12.64 x 18.27 in.)	357 x 529 mm (14.06 x 20.83 in.)
Mounting options <sup>(7)</sup>	<ul style="list-style-type: none"> <li>• Bookshelf</li> <li>• DIN rail</li> <li>• VESA</li> </ul>	<ul style="list-style-type: none"> <li>• Bookshelf</li> <li>• DIN rail</li> <li>• Legacy</li> </ul>	<ul style="list-style-type: none"> <li>• Machine</li> <li>• VESA</li> </ul>	<ul style="list-style-type: none"> <li>• Machine</li> </ul>	<ul style="list-style-type: none"> <li>• Panel (IP65)</li> <li>• VESA (IP20)</li> </ul>			

(1) Soldered.  
(2) Two USB ports are on the front and two are on the rear of these Thin Client models.  
(3) Audio input is not supported currently with ThinManager software.  
(4) Audio output/line out supported. For more information, access Rockwell Automation Knowledgebase article 1083757 at [https://rockwellautomation.custhelp.com/app/answers/detail/a\\_id/1083757](https://rockwellautomation.custhelp.com/app/answers/detail/a_id/1083757).  
(5) These ports support 4K resolution.  
(6) Only cat. no. 6200T-RE includes these four mini display ports; cat. no. 6200T-RC does not.  
(7) All non-display 5200 Thin Client models are shipped with a bookshelf mounting bracket installed, except for cat. nos. 6200T-RC and 6200T-RE. All other mounting methods require an optional mounting bracket, which must be ordered separately.



**Table 10 - Technical Specifications, VersaView 5400 Computers**

Attribute	5400 Industrial Computer Models				
	Non-display	12.1 in. Display	15.6 in. Display	18.5 in. Display	21.5 in. Display
Display type	—	Color active-matrix TFT flat panel			
Display size, diagonal		12.1 in. (307 mm)	15.6 in. (396 mm)	18.5 in. (470 mm)	21.5 in. (546 mm)
Display aspect ratio		16:9			
Display resolution, max		1280 x 800	1366 x 768	1366 x 768	1920 x 1080
Response time, ms		10	8	5	25
Touch screen		PCAP multi-touch			
Bezel		Edge-to-edge glass with aluminum ring			
Available processors		Intel quad-core Atom E3845, 1.91 GHz			
RAM • Type • Supplied/max (GB)	DDR3 <sup>(1)</sup> 4/4	DDR3, SO-DIMM 4/4			
Available storage drives	1 x 128 GB, 2.5 in. SATA MLC SSD				
Expansion slots	—				
Available optical storage device					
CompactFlash type					
SD slot	1 full-size SDHC				
I/O connections	<ul style="list-style-type: none"> <li>• 1 x RS-232, DB9 port</li> <li>• 2 x Ethernet RJ45 LAN ports, 1 Gb each</li> </ul>				
External video connections/ max resolution	<ul style="list-style-type: none"> <li>• 1 x DisplayPort/ 2560 x 1600<sup>(2)</sup></li> <li>• 1 x VGA/1920 x 1440</li> </ul>	1 x DisplayPort/2560 x 1600			
Available operating systems <sup>(3)</sup>	<ul style="list-style-type: none"> <li>• Windows 10 IoT Enterprise (64 bit)<sup>(2)</sup></li> <li>• Windows 7 Pro (64 bit) SP1<sup>(4)</sup></li> <li>• WES 7 (64 bit)</li> </ul>				
Weight, approx	1.78 kg (3.93 lb)	5.0 kg (11.02 lb)	5.9 kg (13 lb)	8.3 kg (18.29 lb)	9.5 kg (20.94 lb)
Dimensions, approx	See <a href="#">page 10</a> .		See <a href="#">page 11</a> .		
Cutout dimensions	—	250 x 312 mm (9.84 x 12.28 in.)	282 x 398 mm (11.1 x 15.67 in.)	321 x 464 mm (12.64 x 18.27 in.)	357 x 529 mm (14.06 x 20.83 in.)
Mounting options <sup>(5)</sup>	<ul style="list-style-type: none"> <li>• Bookshelf</li> <li>• DIN rail</li> <li>• VESA</li> <li>• Legacy</li> <li>• Machine</li> </ul>	<ul style="list-style-type: none"> <li>• Panel (IP65)</li> <li>• VESA (IP20)</li> </ul>			

(1) Soldered.

(2) Audio output/line out supported.

(3) Cat. No. 6200P-NS3C6 uses FactoryTalk® Analytics™ software instead of Microsoft Windows.

(4) 32 bit images for these Windows operating systems are available from the Rockwell Automation Product Compatibility and Download Center (PCDC) website at <https://compatibility.rockwellautomation.com/Pages/home.aspx>.

(5) All non-display 5400 computer models are shipped with a bookshelf mounting bracket installed. All other mounting methods require an optional mounting bracket, which must be ordered separately.

**Figure 1 - VersaView 5200 and 5400 Non-display Computer Dimensions**

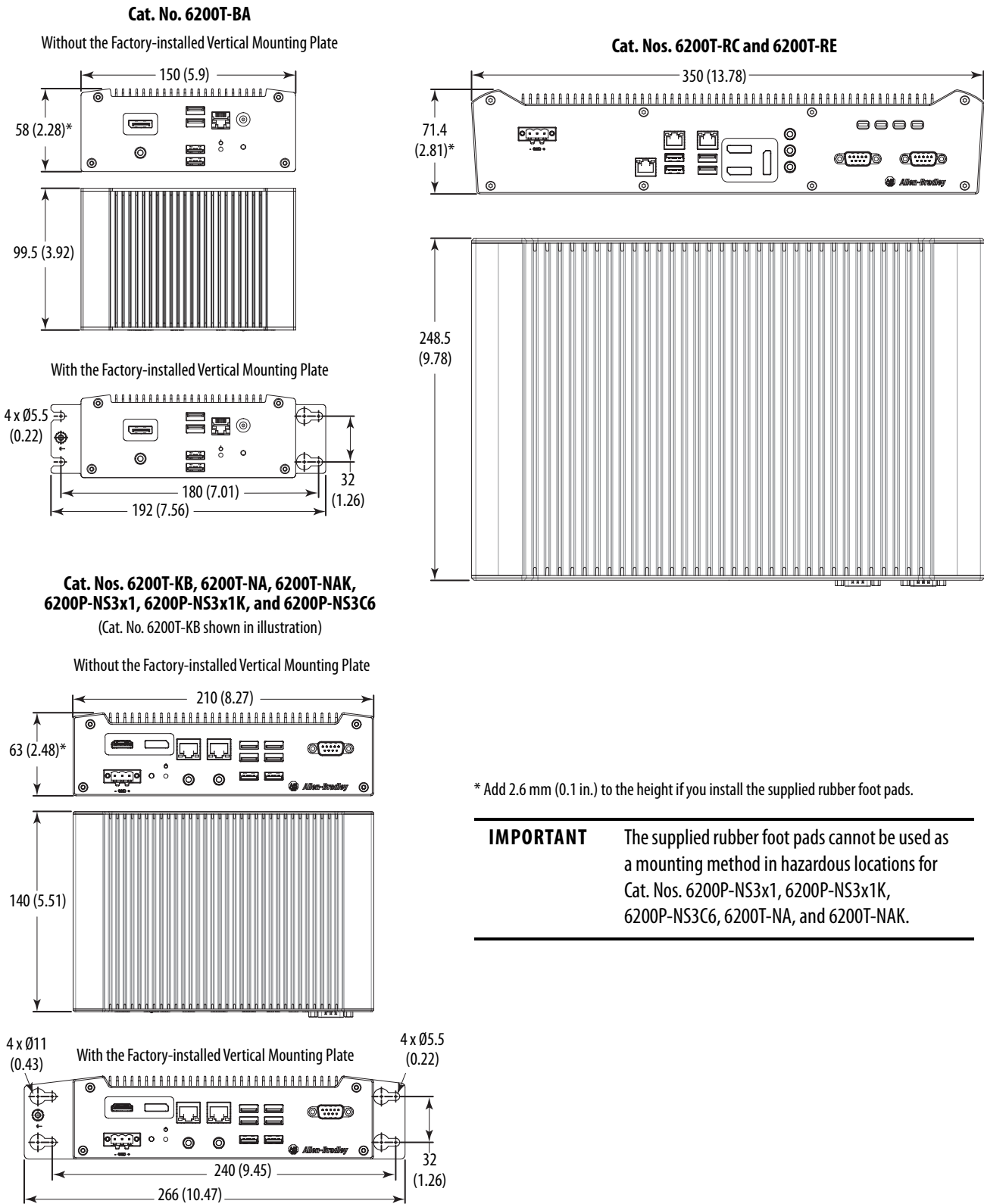

\* Add 2.6 mm (0.1 in.) to the height if you install the supplied rubber foot pads.

**IMPORTANT** The supplied rubber foot pads cannot be used as a mounting method in hazardous locations for Cat. Nos. 6200P-NS3x1, 6200P-NS3x1K, 6200P-NS3C6, 6200T-NA, and 6200T-NAK.

Figure 2 - VersaView 5200 and 5400 Integrated Display Computer Dimensions

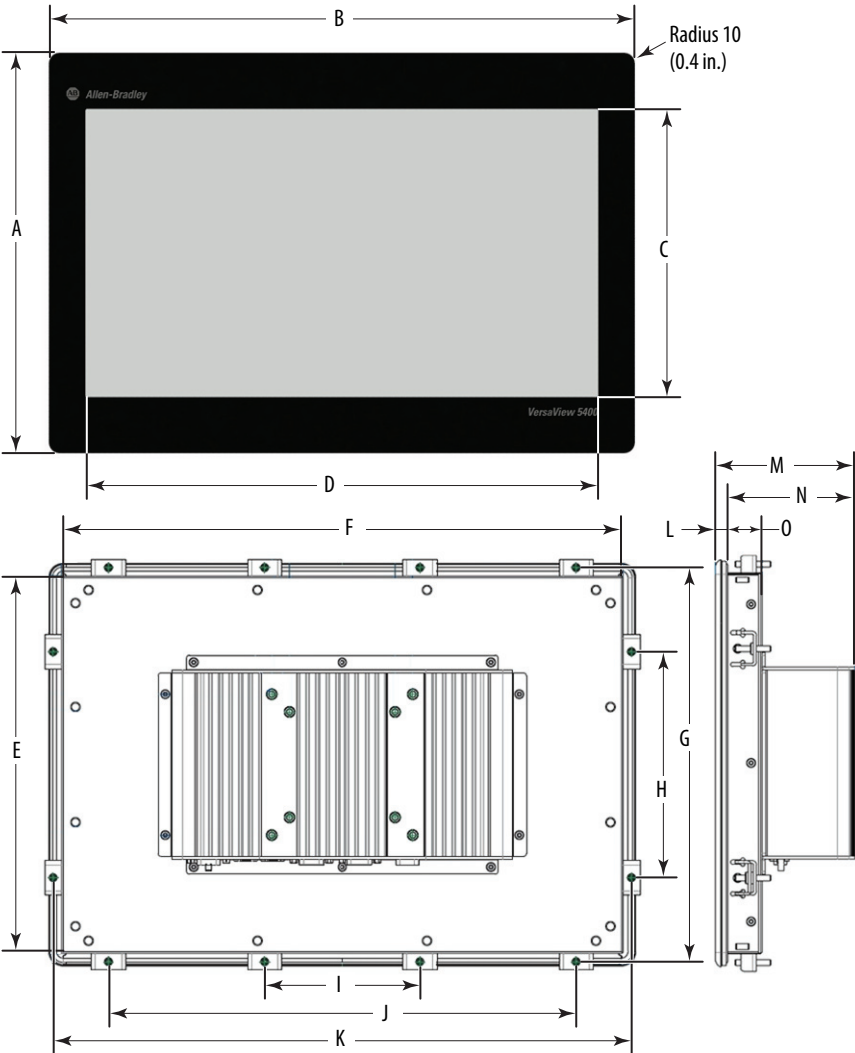

Display Size (in.)	Dimensions, mm (in.)														
	A	B	C	D	E	F	G	H	I	J	K	L <sup>(1)</sup>	M <sup>(2)</sup>	N	O
12.1	266 (10.47)	328 (12.91)	163.2 (6.43)	261 (10.28)	248 (9.76)	310 (12.2)	260 (10.24)	125 (4.92)	200 (7.87)	—	322.5 (12.7)	7.6 (0.3)	97.1 (3.82)	89.5 (3.52)	24.5 (0.97)
15.6	298 (11.73)	414 (16.3)	193.5 (7.61)	344.2 (13.55)	280 (11)	396 (15.6)	292 (11.5)	160 (6.3)	110 (4.33)	330 (13)	408 (16)				
18.5	337 (13.27)	480 (18.9)	230 (9.07)	410 (16.13)	319 (12.56)	462 (18.19)	331 (13.03)	250 (9.84)	130 (5.12)	390 (15.35)	474 (18.66)				
21.5	373 (14.68)	545 (21.46)	268 (10.55)	476.6 (18.76)	355 (14)	527 (20.75)	367 (14.45)	250 (9.84)	150 (5.91)	450 (17.71)	539 (21.22)				

(1) Metric dimension is ±0.5, and the English dimension is ±0.02.  
 (2) Metric dimension is ±1.0, and the English dimension is ±0.04.

## 6181P Integrated Display and Non-display Computers

6181P integrated display and non-display industrial computers serve as the foundation for visualization control with a variety of display sizes, models, and mounting methods. Display sizes are offered in both standard (4:3 and 5:4) format and widescreen (16:9) format. All 6181P computer models feature solid-state drives for performance in storage reliability. Various mounting methods are possible with these computers in landscape and portrait orientations, as well as a space-saving ‘bookshelf’ mounting option on non-display versions.

The complete Rockwell Automation advantage includes seamless integration with the full suite of Rockwell Software® solutions, including Integrated Architecture® and FactoryTalk View software.



6181P Integrated Display Computer



6181P Non-display Computer

**Table 11 - Environmental Specifications, 6181P Integrated Display and Non-display Computers**

Attribute	Advanced	Performance
Temperature, operating		
NDM (non-display)		0...55 °C (32...131 °F)
1200		0...55 °C (32...131 °F)
1500	0...55 °C (32...131 °F) 0...50 °C (32...122 °F) <sup>(3)</sup>	0...55 °C (32...131 °F)
1700	0...55 °C (32...131 °F)	0...55 °C (32...131 °F)
1900	0...50 °C (32...122 °F)	0...50 °C (32...122 °F)
Temperature, nonoperating	-20...+60 °C (-4...+140 °F)	
Relative humidity	10...90% noncondensing at 50%	
Shock, operating <sup>(1)(2)</sup>	15 g (1/2 sine, 11 ms)	
Shock, nonoperating <sup>(1)(2)</sup>	30 g (1/2 sine, 11 ms)	
Vibration, operating <sup>(1)(2)</sup>	0.012 in. p-p, 10...57 Hz, 2 g peak, 57...640 Hz	
Vibration, nonoperating <sup>(1)(2)</sup>	0.018 in. p-p, 10...57 Hz, 3 g peak (57...640 Hz)	
Altitude, operating	Sea level to 2,000 m (6,562 ft)	
Altitude, nonoperating	Sea level to 12,192 m (40,000 ft)	
Enclosure ratings		
• With aluminum bezels	UL50 Type 1, 12, and 4 (indoor use only); IEC 60529, IP66	• UL50 Type 1, 12, and 4 (indoor use only); IEC 60529, IP66
• With stainless steel bezels		• UL50 Type 1, 12, 4, and 4X (indoor use only); IEC 60529, IP66

(1) The optical disk drive is considered a maintenance device. Do not operate the drive in environments with the shock and vibration levels listed. Do not operate the drive in temperatures above 45 °C (113 °F).

(2) Does not apply to bookshelf-mounted non-display computers.

(3) This temperature range applies only to widescreen models.

**Table 12 - Power Specifications, 6181P Integrated Display and Non-display Computers**

Customer Loading	Attribute	All 6181P Advanced Models						All 6181P Performance Models				
		NDM	15 in. widescreen	15 in.	17 in.	19 in. widescreen	19 in.	NDM	12 in.	15 in.	17 in.	19 in.
Typical	Input power, (W)	40	48	47	58	52	66	29	35	36	48	56
	Heat dissipation, (BTU/hr.)	136	164	160	198	177	225	98	119	123	164	191
Maximum	Input power, (W)	140	148	147	158	151	167	113	120	122	136	144
	Heat dissipation, (BTU/hr.)	478	505	502	539	515	570	386	409	416	464	491

Attribute	All 6181P Models
AC models	
Input voltage	100...240V, autoranging
Input power	100...240V; 1.8...0.75 A 50/60 Hz; 180VA
DC models	
Input voltage	18...32V
Input power	18...32V; 10.0...5.63 A; 180 W SELV
Ratings, max	
USB 3.0 port	900 mA <sup>(1)</sup>
PCIe slot	12 W internal, 28 W external (40 W total)

(1) Per port. Maximum of two ports loaded at 900 mA and all other ports at 500 mA.

**Table 13 - Certifications, 6181P Integrated Display and Non-display Computers**

For the most current certification information, visit the Rockwell Automation Literature Library website at <https://www.rockwellautomation.com/global/literature-library/overview.page>. Use 6181P-CT as your search criteria.

Certification	Advanced and Performance Models																																																																					
c-UL-us	For details, see <a href="#">6181P-CT007</a> .																																																																					
CE	For details, see <a href="#">6181P-CT006</a> .																																																																					
EAC (TR CU)	Low Voltage TR CU 004/2011 EMC TR CU 020/2011																																																																					
FCC	Class A emissions																																																																					
KC	For details, see <a href="#">6181P-CT001</a> (12-in.), <a href="#">6181P-CT002</a> and <a href="#">6181P-CT003</a> (15-in.), and <a href="#">6181P-CT004</a> (17-in.).																																																																					
RCM	For details, see <a href="#">6181P-CT005</a> .																																																																					
RoHS	<p>European RoHS 2011/65/EU. For more details, see <a href="#">6181P-CT006</a>.</p> <p>China RoHS:</p> <table border="1"> <thead> <tr> <th rowspan="2">部件名称 Part Name</th> <th colspan="6">有毒有害物质或元素 Toxic or Hazardous Substances and Elements</th> </tr> <tr> <th>铅 Lead (Pb)</th> <th>汞 Mercury (Hg)</th> <th>镉 Cadmium (Cd)</th> <th>六价铬 Hexavalent Chromium (Cr(VI))</th> <th>多溴联苯 Polybrominated Biphenyls (PBB)</th> <th>多溴二苯醚 Polybrominated Diphenyl Ethers (PBDE)</th> </tr> </thead> <tbody> <tr> <td>壳体 Housing</td> <td>X</td> <td>0</td> <td>0</td> <td>0</td> <td>0</td> <td>0</td> </tr> <tr> <td>显示 Display</td> <td>X</td> <td>0</td> <td>0</td> <td>0</td> <td>0</td> <td>0</td> </tr> <tr> <td>印刷电路板 Printed Circuit Board</td> <td>X</td> <td>0</td> <td>0</td> <td>0</td> <td>0</td> <td>0</td> </tr> <tr> <td>金属螺帽 Metal Fasteners</td> <td>X</td> <td>0</td> <td>0</td> <td>0</td> <td>0</td> <td>0</td> </tr> <tr> <td>电缆组装 Cable Assembly</td> <td>X</td> <td>0</td> <td>0</td> <td>0</td> <td>0</td> <td>0</td> </tr> <tr> <td>风扇组装 Fan Assembly</td> <td>X</td> <td>0</td> <td>0</td> <td>0</td> <td>0</td> <td>0</td> </tr> <tr> <td>电力供应组装 Power Supply Assemblies</td> <td>X</td> <td>0</td> <td>0</td> <td>0</td> <td>0</td> <td>0</td> </tr> <tr> <td>电池 Battery</td> <td>0</td> <td>0</td> <td>0</td> <td>0</td> <td>0</td> <td>0</td> </tr> </tbody> </table> <p>本表格依据SJ/T11364 的规定编制。 This table is made per guidance of SJ/T 11364.</p> <p>0: 表示该有害物质在该部件所有均质材料中的含量均在GB/T26572 规定的限量要求以下。 0: Indicates that this toxic or hazardous substance contained in all of the homogeneous materials for the part is below the limit requirement in GB/T 26572.</p> <p>X: 表示该有害物质至少在该部件的某一均质材料中的含量超出GB/T26572 规定的限量要求。 求。(企业可在此处, 根据实际情况对上表中打“X”的技术原因进行进一步说明。) X: Indicates that this toxic or hazardous substance contained in at least one of the homogeneous materials for the part is below the limit requirement in GB/T 26572.</p> <p>Turkey RoHS (EEE Yönetmeliğine Uygundur. In Conformity with the EEE Regulation)</p>	部件名称 Part Name	有毒有害物质或元素 Toxic or Hazardous Substances and Elements						铅 Lead (Pb)	汞 Mercury (Hg)	镉 Cadmium (Cd)	六价铬 Hexavalent Chromium (Cr(VI))	多溴联苯 Polybrominated Biphenyls (PBB)	多溴二苯醚 Polybrominated Diphenyl Ethers (PBDE)	壳体 Housing	X	0	0	0	0	0	显示 Display	X	0	0	0	0	0	印刷电路板 Printed Circuit Board	X	0	0	0	0	0	金属螺帽 Metal Fasteners	X	0	0	0	0	0	电缆组装 Cable Assembly	X	0	0	0	0	0	风扇组装 Fan Assembly	X	0	0	0	0	0	电力供应组装 Power Supply Assemblies	X	0	0	0	0	0	电池 Battery	0	0	0	0	0	0
部件名称 Part Name	有毒有害物质或元素 Toxic or Hazardous Substances and Elements																																																																					
	铅 Lead (Pb)	汞 Mercury (Hg)	镉 Cadmium (Cd)	六价铬 Hexavalent Chromium (Cr(VI))	多溴联苯 Polybrominated Biphenyls (PBB)	多溴二苯醚 Polybrominated Diphenyl Ethers (PBDE)																																																																
壳体 Housing	X	0	0	0	0	0																																																																
显示 Display	X	0	0	0	0	0																																																																
印刷电路板 Printed Circuit Board	X	0	0	0	0	0																																																																
金属螺帽 Metal Fasteners	X	0	0	0	0	0																																																																
电缆组装 Cable Assembly	X	0	0	0	0	0																																																																
风扇组装 Fan Assembly	X	0	0	0	0	0																																																																
电力供应组装 Power Supply Assemblies	X	0	0	0	0	0																																																																
电池 Battery	0	0	0	0	0	0																																																																

**Table 14 - Technical Specifications - 6181P Integrated Display and Non-display Computer NDM, 1200P, and 1500P Models**

Attribute	NDM (non-display)	1200P		1500P	
		Performance		Performance	Advanced
Display type	—	Color active-matrix TFT flat panel			
Display size, diagonal	—	12 in. (307 mm)	15 in. (381 mm)	<ul style="list-style-type: none"> <li>15 in. (381 mm)</li> <li>15.6 in. (396 mm)</li> </ul>	
Display aspect ratio	—	4:3		<ul style="list-style-type: none"> <li>4:3</li> <li>16:9</li> </ul>	
Display resolution (max)	—	XGA 1024 x 768		<ul style="list-style-type: none"> <li>XGA 1024 x 768</li> <li>WXGA 1366 x 768</li> </ul>	
Touch screen	—	Resistive antiglare		PCAP	
Response time	—	15 ms			
Bezel	—	Aluminum	<ul style="list-style-type: none"> <li>Aluminum</li> <li>Stainless steel</li> </ul>	Aluminum	
Available processors	<ul style="list-style-type: none"> <li>Intel Core i3-4102E; 2 cores; 1.6 GHz</li> <li>Intel Core i7-4700EQ; 4 cores; 2.4 GHz</li> </ul>	Intel Core i3-4102E; 2 cores; 1.6 GHz		Intel Core i7-4700EQ; 4 cores; 2.4 GHz	
RAM <ul style="list-style-type: none"> <li>Type</li> <li>Supplied</li> <li>Maximum</li> </ul>	<ul style="list-style-type: none"> <li>DDR3-1600 204-pin SO-DIMM</li> <li>4 GB (2 x 2 GB) or 8 GB (2 x 4 GB)</li> <li>16 GB (2 x 8 GB)<sup>(1)</sup></li> </ul>	<ul style="list-style-type: none"> <li>DDR3-1600 204-pin SO-DIMM</li> <li>4 GB (2 x 2 GB)</li> <li>16 GB (2 x 8 GB)<sup>(1)</sup></li> </ul>		<ul style="list-style-type: none"> <li>DDR3-1600 204-pin SO-DIMM</li> <li>8 GB (2 x 4 GB)</li> <li>16 GB (2 x 8 GB)<sup>(1)</sup></li> </ul>	
Available storage drives	<ul style="list-style-type: none"> <li>1 x 256 GB, 2.5-in. SATA MLC SSD</li> <li>2 x 256 GB, 2.5-in. SATA MLC SSD (RAID 1)</li> <li>1 x 32 GB, 2.5-in. SATA SLC SSD</li> <li>1 x 64 GB, 2.5-in. SATA SLC SSD<sup>(2)</sup></li> </ul>	<ul style="list-style-type: none"> <li>1 x 256 GB, 2.5-in. SATA MLC SSD</li> <li>1 x 32 GB, 2.5-in. SATA SLC SSD</li> <li>1 x 64 GB, 2.5-in. SATA SLC SSD<sup>(2)</sup></li> </ul>			
Expansion slots	1 PCI Express x8 <sup>(3)</sup>				
Available optical storage drive (ODD)	<ul style="list-style-type: none"> <li>None supplied<sup>(4)</sup></li> <li>1 DVD-RW/CD-RW</li> </ul>	None supplied <sup>(4)</sup>		1 DVD-RW/CD-RW	
CompactFlash Type II	Type II slot with cover				
I/O connections	<ul style="list-style-type: none"> <li>1 PS/2™ keyboard port</li> <li>1 PS/2 mouse port</li> <li>2 serial RS-232 COM ports</li> </ul>	<ul style="list-style-type: none"> <li>4 or 5 USB 3.0 external ports<sup>(5)</sup></li> <li>2 Ethernet LAN ports, 1 Gb each</li> <li>DVI-I port</li> </ul>	<ul style="list-style-type: none"> <li>DisplayPort</li> <li>3 jacks: audio line-in, audio line-out, and microphone-in</li> </ul>		
Available operating systems <sup>(6)</sup>	<ul style="list-style-type: none"> <li>Windows 10 IoT Enterprise (64 bit)</li> <li>Windows 7 Pro (64 bit) SP1</li> <li>WES 7 (64 bit) SP1</li> <li>Windows Server 2008 R2 Standard (64 bit) SP1</li> </ul>	<ul style="list-style-type: none"> <li>Windows 10 IoT Enterprise (64 bit)</li> <li>Windows 7 Professional (64 bit) SP1</li> <li>WES 7 (64 bit) SP1</li> </ul>		<ul style="list-style-type: none"> <li>Windows 10 IoT Enterprise (64 bit)</li> <li>Windows 7 Professional (64 bit) SP1</li> </ul>	
Weight, approx <ul style="list-style-type: none"> <li>Aluminum bezel</li> <li>Stainless steel bezel</li> <li>Widescreen</li> </ul>	7.5 kg (16.5 lb) — —	8.5 kg (18.7 lb) — —	9.9 kg (21.8 lb) 11.1 kg (24.5 lb) —	9.9 kg (21.8 lb) — 10.8 kg (23.8 lb)	
Dimensions	See <a href="#">page 17</a> .				
Cutout dimensions					
Mount options	<ul style="list-style-type: none"> <li>Wall</li> <li>Bookshelf<sup>(7)</sup></li> <li>Table top</li> </ul>	Panel			

(1) Maximum memory shipped with computers is 8 GB. 16 GB is available through a kit (catalog number 6189V-16GSODDR3), which is sold separately.

(2) Available through a kit (catalog number 6189V-6181SSD64GB), which is sold separately.

(3) Available one-slot riser kit (catalog number 6189V-PCIR) supports 1 PCI, and two-slot kit (catalog number 6189V-EXTPCI2) supports 2 PCI, 2 PCIe x4, or 1 PCIe x4 plus 1 PCI, all which are half-length.

(4) Performance models are not sold with an optical disk drive (ODD) but one can be installed. You must order a kit (catalog number 6189V-ODD), which is sold separately.

(5) All display models have four external USB 3.0 ports and one internal USB 3.0 port. Display models with an aluminum bezel have an extra external USB 3.0 port on the bezel (behind the front access cover).

(6) 32 bit images for the Windows 7 operating system are available from the Rockwell Automation Product Compatibility and Download Center: <https://compatibility.rockwellautomation.com/Pages/home.aspx>.

(7) A bookshelf mounting kit (catalog number 6189V-BOOKBRKT) is required and must be ordered separately.

**Table 15 - Technical Specifications - 6181P Integrated Display Computer 1700P and 1900P Models**

Attribute	1700P		1900P	
	Performance	Advanced	Performance	Advanced
Display type	Color active-matrix TFT flat panel			
Display size, diagonal	17 in. (432 mm)		19 in. (483 mm)	<ul style="list-style-type: none"> <li>• 19 in. (483 mm)</li> <li>• 18.5 in. (470 mm)</li> </ul>
Display aspect ratio	5:4			<ul style="list-style-type: none"> <li>• 5:4</li> <li>• 16:9</li> </ul>
Display resolution (max)	SXGA 1280 x 1024			<ul style="list-style-type: none"> <li>• SXGA 1280 x 1024</li> <li>• WXGA 1366 x 768</li> </ul>
Touch screen	Resistive antiglare	PCAP	Resistive antiglare	PCAP
Response time	15 ms			
Bezel	<ul style="list-style-type: none"> <li>• Aluminum</li> <li>• Stainless steel</li> </ul>	Aluminum	<ul style="list-style-type: none"> <li>• Aluminum</li> <li>• Stainless steel</li> </ul>	Aluminum
Available processors	Intel Core i3-4102E; 2 cores; 1.6 GHz	Intel Core i7-4700EQ; 4 cores; 2.4 GHz	Intel Core i3-4102E; 2 cores; 1.6 GHz	Intel Core i7-4700EQ; 4 cores; 2.4 GHz
RAM <ul style="list-style-type: none"> <li>• Type</li> <li>• Supplied</li> <li>• Maximum</li> </ul>	<ul style="list-style-type: none"> <li>• DDR3-1600 204-pin SO-DIMM</li> <li>• 4 GB (2 x 2 GB)</li> <li>• 16 GB (2 x 8 GB)<sup>(1)</sup></li> </ul>	<ul style="list-style-type: none"> <li>• DDR3-1600 204-pin SO-DIMM</li> <li>• 8 GB (2 x 4 GB)</li> <li>• 16 GB (2 x 8 GB)<sup>(1)</sup></li> </ul>	<ul style="list-style-type: none"> <li>• DDR3-1600 204-pin SO-DIMM</li> <li>• 4 GB (2 x 2 GB)</li> <li>• 16 GB (2 x 8 GB)<sup>(1)</sup></li> </ul>	<ul style="list-style-type: none"> <li>• DDR3-1600 204-pin SO-DIMM</li> <li>• 8 GB (2 x 4 GB)</li> <li>• 16 GB (2 x 8 GB)<sup>(1)</sup></li> </ul>
Available storage drives	<ul style="list-style-type: none"> <li>• 1 x 256 GB, 2.5-in. SATA MLC SSD</li> <li>• 1 x 32 GB, 2.5-in. SATA SLC SSD</li> <li>• 1 x 64 GB, 2.5-in. SATA SLC SSD<sup>(2)</sup></li> </ul>			
Expansion slots	1 PCI Express x8 <sup>(3)</sup>			
Available optical storage drive (ODD)	None supplied <sup>(4)</sup>	1 DVD-RW/CD-RW	None supplied <sup>(4)</sup>	1 DVD-RW/CD-RW
CompactFlash Type II	Type II slot with cover			
I/O connections	<ul style="list-style-type: none"> <li>• 1 PS/2 keyboard port</li> <li>• 1 PS/2 mouse port</li> <li>• 2 serial RS-232 COM ports</li> </ul>	<ul style="list-style-type: none"> <li>• 4 or 5 USB 3.0 external ports<sup>(5)</sup></li> <li>• 2 Ethernet LAN ports, 1 Gb each</li> <li>• DVI-I port</li> </ul>	<ul style="list-style-type: none"> <li>• DisplayPort</li> <li>• 3 jacks: audio line-in, audio line-out, and microphone-in</li> </ul>	
Available operating systems <sup>(6)</sup>	<ul style="list-style-type: none"> <li>• Windows 10 IoT Enterprise (64 bit)</li> <li>• Windows 7 Professional (64 bit) SP1</li> <li>• WES 7 (64 bit) SP1</li> </ul>	<ul style="list-style-type: none"> <li>• Windows 10 IoT Enterprise (64 bit)</li> <li>• Windows 7 Professional (64 bit) SP1</li> </ul>	<ul style="list-style-type: none"> <li>• Windows 10 IoT Enterprise (64 bit)</li> <li>• Windows 7 Professional (64 bit) SP1</li> <li>• WES 7 (64 bit) SP1</li> </ul>	<ul style="list-style-type: none"> <li>• Windows 10 IoT Enterprise (64 bit)</li> <li>• Windows 7 Professional (64 bit) SP1</li> </ul>
Weight, approx <ul style="list-style-type: none"> <li>• Aluminum bezel</li> <li>• Stainless steel bezel</li> <li>• Widescreen</li> </ul>	11.1 kg (24.5 lb) 12.8 kg (28.2 lb) —	11.1 kg (24.5 lb) — —	13.2 kg (29.1 lb) 14.5 kg (32 lb) —	13.2 kg (29.1 lb) — 13 kg (28.7 lb)
Dimensions, approx	See <a href="#">page 17</a> .			
Cutout dimensions				
Mount options	Panel			

(1) Maximum memory shipped with computers is 8 GB. 16 GB is available through a kit (catalog number 6189V-16GSODDR3), which is sold separately.

(2) Available through a kit (catalog number 6189V-6181SSD64GB), which is sold separately.

(3) Available one-slot riser kit (catalog number 6189V-PCIR) supports 1 PCI, and two-slot kit (catalog number 6189V-EXTPCI2) supports 2 PCI, 2 PCIe x4, or 1 PCIe x4 plus 1 PCI, all which are half-length.

(4) Performance models are not sold with an optical disk drive (ODD) but one can be installed. You must order a kit (catalog number 6189V-ODD), which is sold separately.

(5) All display models have four external USB 3.0 ports and one internal USB 3.0 port. Display models with an aluminum bezel have an extra external USB 3.0 port on the bezel (behind the front access cover).

(6) 32 bit images for the Windows 7 operating system are available from the Rockwell Automation Product Compatibility and Download Center: <https://compatibility.rockwellautomation.com/Pages/home.aspx>.



**Figure 3 - 6181P Integrated Display and Non-display Computer Dimensions**

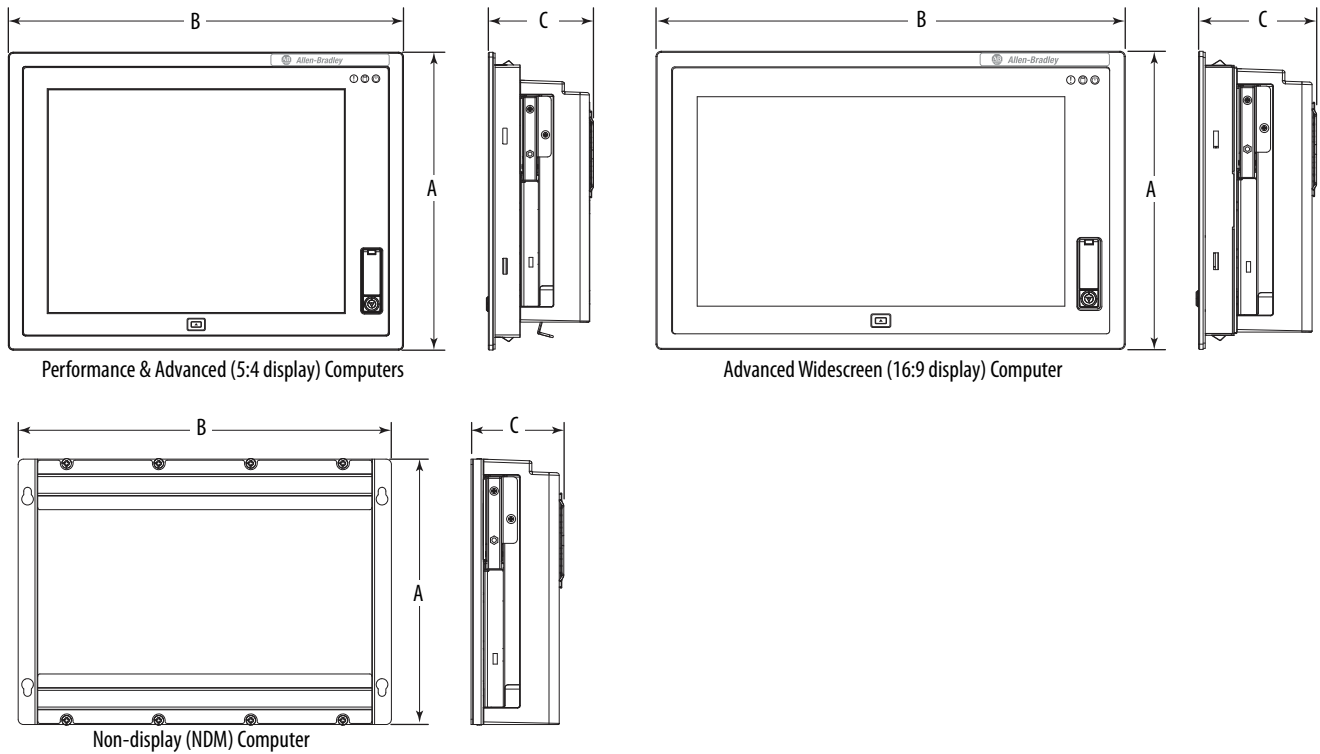

6181P Integrated Display and Non-display Computers	All dimensions are in mm (in.)				
	Overall Height A	Overall Width B	Overall Depth C	Cutout Height	Cutout Width
<b>Non-display (NDM)</b>					
Performance	251 (9.88)	353 (13.9)	83.4 (3.28)	—	—
Advanced			87.7 (3.45)		
<b>1200P</b>					
Performance (aluminum bezel)	279 (10.98)	349 (13.74)	104.8 (4.13)	254 (10)	324 (12.76)
<b>1500P</b>					
Performance (aluminum bezel)	309 (12.16)	410 (16.14)	104.8 (4.13)	285.6 (11.24)	386.6 (15.22)
Performance (stainless steel bezel)			104.1 (4.1)		
Advanced (standard 4:3 display)			104.8 (4.13)		
Advanced (widescreen 16:9 display)	284 (11.18)	447 (17.6)	108.1 (4.26)	260.2 (10.24)	420 (16.54)
<b>1700P</b>					
Performance (aluminum bezel)	356 (14.01)	452 (17.80)	104.8 (4.13)	329.5 (12.97)	424 (16.69)
Performance (stainless steel bezel)			104.1 (4.10)		
Advanced (standard 5:4 display)			104.8 (4.13)		
<b>1900P</b>					
Performance (aluminum bezel)	399.3 (15.72)	482.6 (19)	108.1 (3.94)	363.5 (14.31)	449.6 (17.7)
Performance (stainless steel bezel)					
Advanced (standard 5:4 display)					
Advanced (widescreen 16:9 display)					

**NOTE:** All Advanced integrated display computer models are available only with aluminum bezels.

## 6181X Integrated Display and Non-display Computers for Hazardous Locations

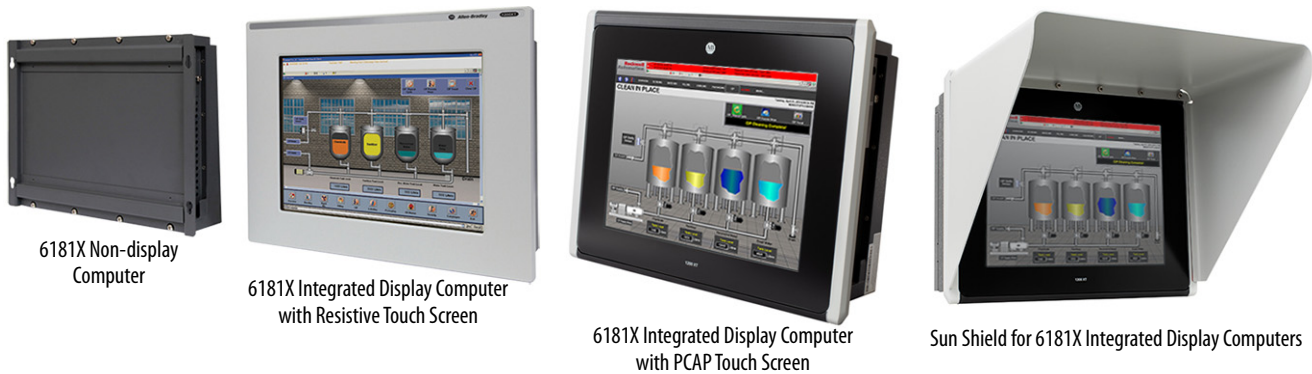



With UL Class 1 Div. 2, ATEX, INMETRO, and IECEx hazardous location certifications, this extreme environment computer can be safely used globally in areas where explosive materials can be present. The display version of this computer mounts in a panel while the non-display version mounts on a wall. All integrated display computers can withstand temperatures of -20...+70 °C (-4...+158 °F) inside a cabinet or enclosure. The front of the integrated display computers can withstand ambient temperatures in the range -20...+55 °C (-4...+131 °F).

A sun shield (Cat. No. 6189X-SUNSHIELD) is available for 6181X integrated display computers to be installed outdoors. Adding a sun shield helps protect against direct and long-term exposure to sunlight, ultraviolet radiation, and infrared radiation, all which can reduce the field life of an electronic device. Rockwell Automation does not recommend collapsible sun shields for 6181X integrated display computers in outdoor installations.

**Table 16 - Environmental Specifications, 6181X Hazardous Location Computers**

Attribute	Non-display Models	Display Models	
	Cat. Nos. 6181X-00N2SW71DC, 6181X-00N2SWX1DC	Cat. No. 6181X-12TPXPDC (PCAP Touch Screen)	Cat. Nos. 6181X-12A2SW71DC, 6181X-12A2SWX1DC (Resistive Touch Screen)
Temperature, operating	-20...+70 °C (-4...+158 °F)	-20...+55 °C (-4...+131 °F), display side -20...+70 °C (-4...+158 °F), back side	
Temperature, nonoperating	-30...+80 °C (-22...+176 °F)		
Relative humidity	10...90% noncondensing		
Altitude, operating	2,000 m (6,561 ft)		
Altitude, nonoperating	12,000 m (39,370 ft)		
Vibration, operating	0.012 in. p-p 10...57 Hz 2 g peak at 57...640 Hz		
Shock, operating	15 g (1/2 sine, 11 ms)		
Shock, nonoperating	30 g (1/2 sine, 11 ms)		
Enclosure ratings (display models)	Rated for UL Type 1, 4, 4X, 12, 13 and classified by UL in accordance with IEC 60529, IP66 when properly mounted on a flat surface of an equivalent-type enclosure.		

**Table 17 - Hazardous Location Ratings by Region, 6181X Hazardous Location Computers**

Computer Model	Cat. Nos.	Region	Rating	Temperature Range
Non-display	6181X-00N2SW71DC, 6181X-00N2SWX1DC	United States	Class I Division 2, Groups A, B, C, D T4	-20 °C ≤ T <sub>a</sub> ≤ 70 °C (-4 °F ≤ T <sub>a</sub> ≤ 158 °F)
			Class I Zone 2, IIC, T4	
		Canada	Class I Division 2, Groups A, B, C, D T4	
			Class I Zone 2, IIC, T4	
		Europe (ATEX)	 II 3 G, Ex ec IIC T4 Gc, DEMKO 19 ATEX 2274 X	
Global/IECEX	Ex ec IIC T4 Gc, IECEX UL 19.0091 X			
		INMETRO	Ex ec IIC T4 Gc, UL-BR 19.1305 X	
Display (12 in.)	6181X-12P2SWX1DC	United States	Class I Division 2, Groups A, B, C, D T4	-20 °C ≤ T <sub>a</sub> ≤ 55 °C (-4 °F ≤ T <sub>a</sub> ≤ 131 °F) (display side)
			Class II Division 2, Groups F, G T6	
			Class III Division 1 T6	-20 °C ≤ T <sub>a</sub> ≤ 70 °C (-4 °F ≤ T <sub>a</sub> ≤ 158 °F) (backside)
		Canada	Class I Zone 2, IIC, T4	
			Class II Zone 22, IIIB, T70 °C	
		Europe (ATEX)	Class I Division 2, Groups A, B, C, D T4	
Class II Division 2, Groups F, G T6				
	Class III Division 1 T6			
	Class I Zone 2, IIC, T4			
	Class II Zone 22, IIIB, T70 °C			
	Europe (ATEX)	 II 3 GD, Ex ec IIC T4 Gc IP66, Ex tc IIIC T70 °C Dc IP66, DEMKO 19 ATEX 2274 X		
	Global/IECEX	Ex ec IIC T4 Gc IP66, Ex tc IIIC T70 °C Dc IP66, IECEX UL 19.0091 X		
		INMETRO	Ex ec IIC T4 Gc IP66, Ex tc IIIC T70 °C Dc IP66, UL-BR 19.1305 X	
Display (12 in.)	6181X-12A2SW71DC, 6181X-12A2SWX1DC	United States	Class I Division 2, Groups A, B, C, D T4	-20 °C ≤ T <sub>a</sub> ≤ 55 °C (-4 °F ≤ T <sub>a</sub> ≤ 131 °F) (display side)
			Class I Zone 2, IIC, T4	
		Canada	Class I Division 2, Groups A, B, C, D T4	-20 °C ≤ T <sub>a</sub> ≤ 70 °C (-4 °F ≤ T <sub>a</sub> ≤ 158 °F) (backside)
			Class I Zone 2, IIC, T4	
		Europe (ATEX)	 II 3 GD, Ex nA nC IIC T4 Gc IP66, Ex tc IIIC T135 °C Dc IP66, DEMKO 17 ATEX 1851 X	
Global/IECEX	Ex nA nC IIC T4 Gc IP66, Ex tc IIIC T135 °C Dc IP66, IECEX UL 17.0024 X			

**Table 18 - Certifications, 6181X Hazardous Location Computers**

For the most current certification information, visit the Rockwell Automation Literature Library website at <https://www.rockwellautomation.com/global/literature-library/overview.page>. Use 6181X-CT as your search criteria.

Certification	All 6181X Hazardous Location Computers																																																																					
ATEX	For details, see <a href="#">6181X-CT012</a> .																																																																					
CE	For details, see <a href="#">6181X-CT010</a> .																																																																					
c-UL-us	For details, see <a href="#">6181X-CT007</a> .																																																																					
EAC	For details, see <a href="#">IC-CT001</a> .																																																																					
FCC	Class A emissions																																																																					
IECEX	For details, see <a href="#">6181X-CT011</a> .																																																																					
KC	For details, see <a href="#">6181X-CT009</a> .																																																																					
RCM (formerly C-Tick)	Australian Radiocommunications Act, compliance with EN 55032. For more details, see <a href="#">6181X-CT008</a> .																																																																					
RoHS	<p>European RoHS 2011/65/EU. For more details, see <a href="#">6181X-CT010</a>. China RoHS:</p> <table border="1"> <thead> <tr> <th rowspan="2">部件名称 Part Name</th> <th colspan="6">有毒有害物质或元素 Toxic or Hazardous Substances and Elements</th> </tr> <tr> <th>铅 Lead (Pb)</th> <th>汞 Mercury (Hg)</th> <th>镉 Cadmium (Cd)</th> <th>六价铬 Hexavalent Chromium (Cr(VI))</th> <th>多溴联苯 Polybrominated Biphenyls (PBB)</th> <th>多溴二苯醚 Polybrominated Diphenyl Ethers (PBDE)</th> </tr> </thead> <tbody> <tr> <td>壳体 Housing</td> <td>X</td> <td>0</td> <td>0</td> <td>0</td> <td>0</td> <td>0</td> </tr> <tr> <td>显示 Display</td> <td>X</td> <td>0</td> <td>0</td> <td>0</td> <td>0</td> <td>0</td> </tr> <tr> <td>印刷电路板 Printed Circuit Board</td> <td>X</td> <td>0</td> <td>0</td> <td>0</td> <td>0</td> <td>0</td> </tr> <tr> <td>金属螺帽 Metal Fasteners</td> <td>X</td> <td>0</td> <td>0</td> <td>0</td> <td>0</td> <td>0</td> </tr> <tr> <td>电缆组装 Cable Assembly</td> <td>X</td> <td>0</td> <td>0</td> <td>0</td> <td>0</td> <td>0</td> </tr> <tr> <td>风扇组装 Fan Assembly</td> <td>X</td> <td>0</td> <td>0</td> <td>0</td> <td>0</td> <td>0</td> </tr> <tr> <td>电力供应组装 Power Supply Assemblies</td> <td>X</td> <td>0</td> <td>0</td> <td>0</td> <td>0</td> <td>0</td> </tr> <tr> <td>电池 Battery</td> <td>0</td> <td>0</td> <td>0</td> <td>0</td> <td>0</td> <td>0</td> </tr> </tbody> </table> <p>本表格依据SJ/T11364 的规定编制。 This table is made per guidance of SJ/T 11364.</p> <p>0: 表示该有害物质在该部件所有均质材料中的含量均在GB/T26572 规定的限量要求以下。 0: Indicates that this toxic or hazardous substance contained in all of the homogeneous materials for the part is below the limit requirement in GB/T 26572.</p> <p>X: 表示该有害物质至少在该部件的某一均质材料中的含量超出GB/T26572 规定的限量要求。 求。(企业可在此处,根据实际情况对上表中打“×”的技术原因进行进一步说明。) X: Indicates that this toxic or hazardous substance contained in at least one of the homogeneous materials for the part is below the limit requirement in GB/T 26572.</p> <p>Turkey RoHS (EEE Yönetmeliğine Uygundur. In Conformity with the EEE Regulation)</p>	部件名称 Part Name	有毒有害物质或元素 Toxic or Hazardous Substances and Elements						铅 Lead (Pb)	汞 Mercury (Hg)	镉 Cadmium (Cd)	六价铬 Hexavalent Chromium (Cr(VI))	多溴联苯 Polybrominated Biphenyls (PBB)	多溴二苯醚 Polybrominated Diphenyl Ethers (PBDE)	壳体 Housing	X	0	0	0	0	0	显示 Display	X	0	0	0	0	0	印刷电路板 Printed Circuit Board	X	0	0	0	0	0	金属螺帽 Metal Fasteners	X	0	0	0	0	0	电缆组装 Cable Assembly	X	0	0	0	0	0	风扇组装 Fan Assembly	X	0	0	0	0	0	电力供应组装 Power Supply Assemblies	X	0	0	0	0	0	电池 Battery	0	0	0	0	0	0
部件名称 Part Name	有毒有害物质或元素 Toxic or Hazardous Substances and Elements																																																																					
	铅 Lead (Pb)	汞 Mercury (Hg)	镉 Cadmium (Cd)	六价铬 Hexavalent Chromium (Cr(VI))	多溴联苯 Polybrominated Biphenyls (PBB)	多溴二苯醚 Polybrominated Diphenyl Ethers (PBDE)																																																																
壳体 Housing	X	0	0	0	0	0																																																																
显示 Display	X	0	0	0	0	0																																																																
印刷电路板 Printed Circuit Board	X	0	0	0	0	0																																																																
金属螺帽 Metal Fasteners	X	0	0	0	0	0																																																																
电缆组装 Cable Assembly	X	0	0	0	0	0																																																																
风扇组装 Fan Assembly	X	0	0	0	0	0																																																																
电力供应组装 Power Supply Assemblies	X	0	0	0	0	0																																																																
电池 Battery	0	0	0	0	0	0																																																																

**Table 19 - Power Specifications, 6181X Hazardous Location Computers**

Attribute	Non-display Models	Integrated Display Models	
	Cat. Nos. 6181X-00N2SW71DC, 6181X-00N2SWX1DC	Cat. Nos. 6181X-12A2SW71DC, 6181X-12A2SWX1DC,	Cat. No. 6181X-12P2SWX1DC
Input voltage	18...32V DC		
Power consumption, max	18...32V DC (SELV), 2.22...1.25 A, 40 W	18...32V DC (SELV), 2.78...1.56 A, 50 W	18...32V DC (SELV), 3.28...1.79 A, 60 W
Heat dissipation <sup>(1)</sup>	40 W (154 BTU/h)	50 W (171 BTU/h)	60 W (205 BTU/h)
Peripheral loading • PCIe card, max • USB ports, max per port	4 W 900 mA, 10 W max for all ports (2 A)	4 W 900 mA	

(1) Add-in cards and peripherals are included in the heat dissipation value.

**Table 20 - Technical Specifications, 6181X Hazardous Location Computers**

Attribute	Non-display Models	Integrated Display Models	
	Cat. Nos. 6181X-00N2SW71DC, 6181X-00N2SWX1DC	Cat. Nos. 6181X-12A2SW71DC, 6181X-12A2SWX1DC	Cat. No. 6181X-12P2SWX1DC
Display type	No display	Active matrix color TFT	Projected capacitive (PCAP)
Touch screen	—	Resistive, sunlight readable film	Chemically strengthened glass with matte finish to help reduce glare. Supports 10-point multi-touch operation.
Display size, diagonal	308 mm (12.1 in.)		
Display area (WxH)	246 x 185 mm (9.7 x 7.3 in.)		
Native resolution	1024 x 768, 16.2M colors		
Luminance	700 cd/m <sup>2</sup> (Nits)		1300 cd/m <sup>2</sup> (Nits)
Contrast ratio, typical	800:1		
View angle, typical	160°		
LED backlight lifetime	100,000 hours max at 25 °C (77 °F)		100,000 hours
Bezel	Aluminum		
Processor	Intel Core i3-5010U, 2.1 GHz		
RAM	8 GB DDR3 installed (16 GB max)		
Solid-state drive • Installed • Max	MLC drive on computer side, 128 GB <sup>(1)</sup> • 128 GB • 256 GB		
Expansion slots	1 half-length PCIe <sup>(2)</sup>		
CompactFlash (CF) Type II slot	SLC™ drive on computer bottom (bootable, shipped empty) <sup>(3)</sup>		
I/O connections	<ul style="list-style-type: none"> <li>• 2 serial RS-232 COM ports</li> <li>• 4 USB 2.0 ports, hot-swappable</li> <li>• 2 Ethernet LAN ports, 1 Gb each</li> <li>• 2 video ports: 1 DVI-I and 1 DisplayPort</li> </ul>		
Available operating systems	<ul style="list-style-type: none"> <li>• Windows 10 IoT Enterprise (64 bit)</li> <li>• Windows 7 Professional (64 bit), Service Pack 1</li> </ul>		
Weight, approx	6.7 kg (14.8 lb)	9 kg (19.8 lb)	9.4 kg (20.7 lb)
Dimensions, approx	See <a href="#">page 22</a> .		
Cutout dimensions			
Mount options	Wall	Panel	

(1) 256 GB hard disk drive accessory available, cat. no. 6189X-256GBSSD.

(2) A PCI card is available (Cat. No. 6189X-PCIRISER) that can be used in Cat. Nos. 6181X-00N2SW71DC, 6181X-00N2SWX1DC, and 6181X-12P2SWX1DC.

(3) The CF card slot on the bottom side of all computer models is hot-swappable but only in a non-hazardous location.

**Figure 4 - 6181X Hazardous Location Computer Dimensions**

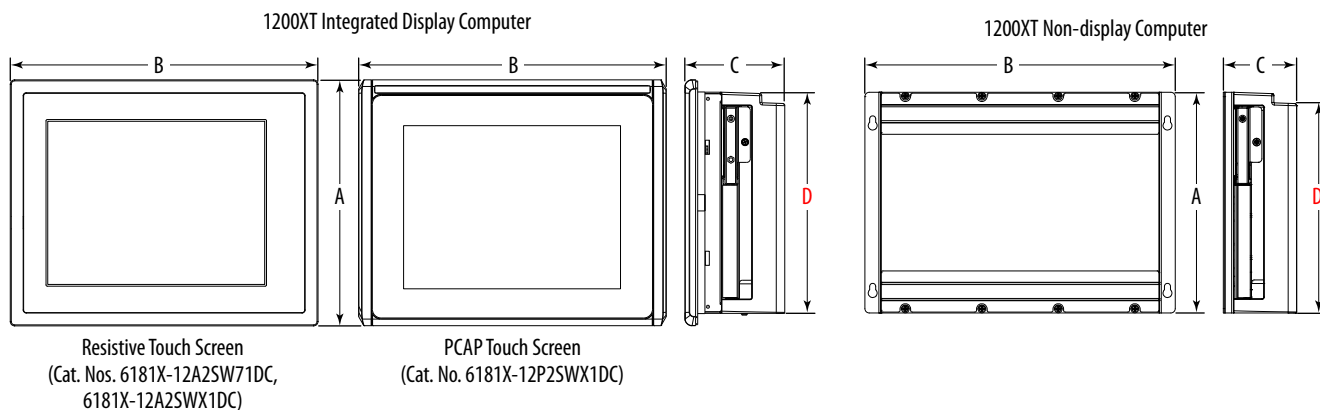

6181X Hazardous Location Computer	All dimensions are in mm (in.)					
	A Overall Height	B Overall Width	C Overall Depth	D Backside Height	Cutout Height	Cutout Width
1200XT display	279 (10.98)	349 (13.74)	101.2 (3.98)	251 (9.88)	254 (10)	324 (12.76)
1200XT non-display	251 (9.88)	335 (13.20)	83.4 (3.28)	238.2 (9.37)	—	—

**6177R Non-display Computers**

The 6177R non-display computers take advantage of the second generation Intel Core processors to provide powerful platforms that are suited with excellent reliability for industrial environments. These computers are available in rugged machine-mount and rack-mount form factors and offer powerful remote management, onboard backup/restore, and integrated diagnostic capabilities.



**Table 21 - Environmental Specifications, 6177R Non-display Computers**

Attribute	750R, 1450R	
Temperature, operating	0...50 °C (32...122 °F)	
Temperature, nonoperating	-20...+60 °C (-4...+140 °F)	
Relative humidity	10...90% noncondensing	
Vibration, operating	0.006 in. p-p 10...57 Hz, 1 g peak at 57...640 Hz	
Vibration, nonoperating	0.012 in. p-p 10...57 Hz, 2 g peak at 57...640 Hz	
Shock, operating	15 g (1/2 sine, 11 ms)	
Shock, nonoperating	30 g (1/2 sine, 11 ms)	
Acoustic noise, idle	750R	44.3 dB at 50 cm
	1450R	46.6 dB at 50 cm
Acoustic noise, max	750R	63.4 dB at 50 cm
	1450R	64.4 dB at 50 cm

**Table 22 - Certifications, 6177R Non-display Computers**

For the most current certification information, visit the Rockwell Automation Literature Library website at <https://www.rockwellautomation.com/global/literature-library/overview.page>. Use 6177R-CT as your search criteria.

Certification	750R, 1450R																																																																					
c-UL-us	For details, see <a href="#">6177R-CT005</a> .																																																																					
CE	For details, see <a href="#">6177R-CT004</a> .																																																																					
FCC	Class A emissions																																																																					
KC	For details, see <a href="#">6177R-CT001</a> , <a href="#">6177R-CT002</a> , and <a href="#">6177R-CT003</a> .																																																																					
RoHS	<p>European RoHS 2011/65/EU. For more details, see <a href="#">6177R-CT004</a>.</p> <p>China RoHS:</p> <table border="1"> <thead> <tr> <th rowspan="2">部件名称 Part Name</th> <th colspan="6">有毒有害物质或元素 Toxic or Hazardous Substances and Elements</th> </tr> <tr> <th>铅 Lead (Pb)</th> <th>汞 Mercury (Hg)</th> <th>镉 Cadmium (Cd)</th> <th>六价铬 Hexavalent Chromium (Cr(VI))</th> <th>多溴联苯 Polybrominated Biphenyls (PBB)</th> <th>多溴二苯醚 Polybrominated Diphenyl Ethers (PBDE)</th> </tr> </thead> <tbody> <tr> <td>壳体 Housing</td> <td>X</td> <td>0</td> <td>0</td> <td>0</td> <td>0</td> <td>0</td> </tr> <tr> <td>显示 Display</td> <td>X</td> <td>0</td> <td>0</td> <td>0</td> <td>0</td> <td>0</td> </tr> <tr> <td>印刷电路板 Printed Circuit Board</td> <td>X</td> <td>0</td> <td>0</td> <td>0</td> <td>0</td> <td>0</td> </tr> <tr> <td>金属螺帽 Metal Fasteners</td> <td>X</td> <td>0</td> <td>0</td> <td>0</td> <td>0</td> <td>0</td> </tr> <tr> <td>电缆组装 Cable Assembly</td> <td>X</td> <td>0</td> <td>0</td> <td>0</td> <td>0</td> <td>0</td> </tr> <tr> <td>风扇组装 Fan Assembly</td> <td>X</td> <td>0</td> <td>0</td> <td>0</td> <td>0</td> <td>0</td> </tr> <tr> <td>电力供应组装 Power Supply Assemblies</td> <td>X</td> <td>0</td> <td>0</td> <td>0</td> <td>0</td> <td>0</td> </tr> <tr> <td>电池 Battery</td> <td>0</td> <td>0</td> <td>0</td> <td>0</td> <td>0</td> <td>0</td> </tr> </tbody> </table> <p>本表格依据SJ/T11364 的规定编制。 This table is made per guidance of SJ/T 11364.</p> <p>0: 表示该有害物质在该部件所有均质材料中的含量均在GB/T26572 规定的限量要求以下。 0: Indicates that this toxic or hazardous substance contained in all of the homogeneous materials for the part is below the limit requirement in GB/T 26572.</p> <p>X: 表示该有害物质至少在该部件的某一均质材料中的含量超出GB/T26572 规定的限量要求。 求。(企业可在此处, 根据实际情况对上表中打“X”的技术原因进行进一步说明。) X: Indicates that this toxic or hazardous substance contained in at least one of the homogeneous materials for the part is below the limit requirement in GB/T 26572.</p> <p>Turkey RoHS (EEE Yönetmeliğine Uygundur. In Conformity with the EEE Regulation)</p>	部件名称 Part Name	有毒有害物质或元素 Toxic or Hazardous Substances and Elements						铅 Lead (Pb)	汞 Mercury (Hg)	镉 Cadmium (Cd)	六价铬 Hexavalent Chromium (Cr(VI))	多溴联苯 Polybrominated Biphenyls (PBB)	多溴二苯醚 Polybrominated Diphenyl Ethers (PBDE)	壳体 Housing	X	0	0	0	0	0	显示 Display	X	0	0	0	0	0	印刷电路板 Printed Circuit Board	X	0	0	0	0	0	金属螺帽 Metal Fasteners	X	0	0	0	0	0	电缆组装 Cable Assembly	X	0	0	0	0	0	风扇组装 Fan Assembly	X	0	0	0	0	0	电力供应组装 Power Supply Assemblies	X	0	0	0	0	0	电池 Battery	0	0	0	0	0	0
部件名称 Part Name	有毒有害物质或元素 Toxic or Hazardous Substances and Elements																																																																					
	铅 Lead (Pb)	汞 Mercury (Hg)	镉 Cadmium (Cd)	六价铬 Hexavalent Chromium (Cr(VI))	多溴联苯 Polybrominated Biphenyls (PBB)	多溴二苯醚 Polybrominated Diphenyl Ethers (PBDE)																																																																
壳体 Housing	X	0	0	0	0	0																																																																
显示 Display	X	0	0	0	0	0																																																																
印刷电路板 Printed Circuit Board	X	0	0	0	0	0																																																																
金属螺帽 Metal Fasteners	X	0	0	0	0	0																																																																
电缆组装 Cable Assembly	X	0	0	0	0	0																																																																
风扇组装 Fan Assembly	X	0	0	0	0	0																																																																
电力供应组装 Power Supply Assemblies	X	0	0	0	0	0																																																																
电池 Battery	0	0	0	0	0	0																																																																
RCM	Emissions standards: AS/NZS CISPR 22 Class A																																																																					

**Table 23 - Technical Specifications, 6177R Non-display Computers**

Attribute	750R	1450R
Display type	Requires external monitor	Requires external monitor
Available operating systems	Windows 10 IoT Enterprise (64 bit), Windows 7 Professional (64 bit) SP1, or no operating system	
Performance	Windows 10 IoT Enterprise (64 bit), Windows Embedded 8.1 Industry Professional, or Windows 7 Professional (64 bit) SP1	
Advanced	Windows Server 2012 Standard R2, Windows Server 2008 R2 SP1, or no operating system	
Server		
Processor	Intel Core i3-2120, 3.3 GHz Intel Core i5-2400, 3.1 GHz Intel Core i5-2400, 3.1 GHz	Intel Core i3-2120, 3.3 GHz Intel Core i5-2400, 3.1 GHz Intel Core i5-2400, 3.1 GHz
Ethernet LAN	2 ports, 10/100/1000 Mbps	
RAM memory	4 GB DDR3, 32 GB max 8 GB DDR3, 32 GB max 8 GB DDR3, 32 GB max	4 GB DDR3, 32 GB max 8 GB DDR3, 32 GB max 8 GB DDR3, 32 GB max
Storage drive <sup>(1)</sup>	(1) 500 GB, 3.5-in. SATA HDD (1) 500 GB, 3.5-in. SATA HDD (2) 500 GB, 3.5-in. SATA HDD	(1) 500 GB, 3.5-in. SATA HDD (1) 500 GB, 3.5-in. SATA HDD (2) 500 GB, 3.5-in. SATA HDD
RAID 1 enabled	No No Yes	No No Yes
RAID capabilities	RAID 0 or RAID 1 with second HDD installed and RAID array configured	
Optical disk drive (ODD)	DVD-RW	DVD-RW
Expansion slots	<ul style="list-style-type: none"> <li>• 1 PCI (750R) or 4 PCI (1450R)</li> <li>• 1 PCI Express x16</li> <li>• 1 PCI Express x4</li> <li>• 1 PCI Express x1</li> </ul>	
I/O ports	<ul style="list-style-type: none"> <li>• 1 PS/2 keyboard</li> <li>• 1 PS/2 mouse</li> <li>• 2 serial</li> <li>• 1 parallel</li> <li>• 2 Ethernet LAN ports, 1 Gb each</li> <li>• 7 USB 2.0 ports (4 rear, 2 front, 1 internal)</li> <li>• 2 USB 3.0 ports (1 rear, 1 front)</li> <li>• 1 eSATAp (5V, 500 mA)</li> <li>• 2 DVI (DVI-1, DVI-D) DVI-1 port converts to VGA with supplied adapter</li> <li>• Audio line in, audio line out and microphone</li> </ul>	
Input voltage, AC	100...240V, autoranging	
Line frequency	50...60 Hz	
Power consumption, AC	10 A at 100V rms, 5 A at 240V rms	
Weight, approx	13.8 kg (30.36 lb)	14.0 kg (30.80 lb)
Dimensions, approx	See <a href="#">page 25</a> .	
Mount options	Machine mount	4U rack mount

(1) A 1 TB, 3.5-in. SATA HDD is available as an accessory (cat. no. 6189V-35HDD1TB) for all 750R and 1450R computer models.



Figure 5 - 6177R Non-display Computer Dimensions

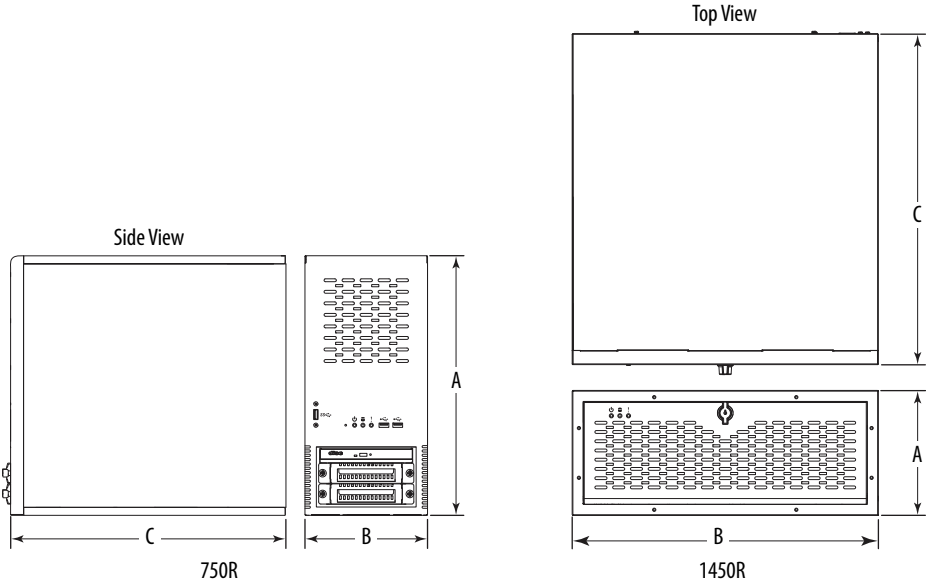

6177R Computer	All dimensions are in mm (in.)		
	Overall Height A	Overall Width B	Overall Depth C
750R	360 (14.17)	170 (6.69)	381 (15.01)
1450R	176 (6.93)	431 (16.97)	465 (18.31)

## 6189V Industrial Keyboard and Pointing Device Accessories



Cat. No.	Description (Connection Port)	Operating Temp. Range	Power Required @ 5V	Cable Length, m (ft)	Weight, lbs (kg)	
6189V-HPMOUSE	Pointing device, SS <sup>(1)</sup> (PS/2™)	-20...+60 °C (-4...+140 °F)	35 mA	3 (10)	0.57 (1.25)	
6189V-HPMOUSEP	Panel-mount pointing device, SS (PS/2)					
6189V-HPMOUSEPU	Panel-mount pointing device, SS (USB)					
6189V-HPMOUSEU	Desktop mouse, SS (USB)					
6189V-KBDEPC1U	Desktop keyboard with pointing device, PC <sup>(2)</sup> (USB)	200 mA	1.02 (2.25)			
6189V-KBDEPP1UC	Desktop keyboard with pointing device, PC (USB)	235 mA	0.9 (2)			
6189V-KBDEPS1	Desktop keyboard with pointing device, SS (PS/2)	-20...+60 °C (-4...+140 °F)	35 mA	3 (10)	2.38 (5.25)	
6189V-KBDEPS1U	Desktop keyboard with pointing device, SS (USB)					
6189V-KBPEPS1	Panel-mount keyboard with pointing device, SS (PS/2)					
6189V-KBPEPS1U	Panel-mount keyboard with pointing device, SS (USB)					
6189V-MOUSEU	Fully sealed, waterproof optical mouse, PC (USB)	0...50 °C (32...122 °F)	100 mA		1.6 (5.25)	0.1 (0.2)

(1) SS = stainless steel  
 (2) PC = polycarbonate

**Table 24 - 6189V Accessories Certifications**

For the most current certification information, visit the Rockwell Automation Literature Library website at <https://www.rockwellautomation.com/global/literature-library/overview.page>. Use 6189V-CT as your search criteria.

Certification	6189V Accessories
CE	For details, see <a href="#">6189V-CT001</a> .
FCC	Part 15 Subpart B emissions
KC	For details, see <a href="#">6189V-CT002</a> , <a href="#">6189V-CT003</a> , and <a href="#">6189V-CT004</a> .
RoHS	European RoHS 2011/65/EU. For more details, see <a href="#">6189V-CT001</a> .

## Rockwell Automation Industrial Monitors

Rockwell Automation industrial monitors deliver the latest in LCD flat panel technology for rugged industrial environments. VersaView 5100 monitors are designed for applications that require widescreen and multi-touch content. Their stainless steel construction allows them to be used in NEMA 4X and IEC IP66 environments. Bulletin 6186M monitors are better suited for special purpose environments such as UL Class 1 division 2, and food and beverage areas. Bulletin 6176M monitors are designed for environments that are less demanding but still must maintain endurance to temperature, shock and vibration.

To help with your purchase, the following table compares the various industrial monitor features.

**Table 25 - Industrial Monitors Comparison**

Characteristic	Industrial Monitor Model		
	VersaView 5100	6176M	6186M
Display	<ul style="list-style-type: none"> <li>12.1 in. widescreen color TFT</li> <li>15.6 in. widescreen color TFT</li> <li>18.5 in. widescreen color TFT</li> <li>21.5 in. widescreen color TFT</li> </ul>	<ul style="list-style-type: none"> <li>1550M: 15 in. color TFT</li> <li>1750M: 17 in. color TFT</li> <li>1950M: 19 in. color TFT</li> </ul>	<ul style="list-style-type: none"> <li>1200M: 12.1 in. color TFT</li> <li>1500M: 15 in. color TFT</li> <li>1700M: 17 in. color TFT</li> <li>1900M: 19 in. color TFT</li> </ul>
Available bezels	Tempered glass with stainless steel ring	<ul style="list-style-type: none"> <li>Aluminum</li> <li>Plastic</li> </ul>	<ul style="list-style-type: none"> <li>Aluminum</li> <li>Stainless steel</li> </ul>
Resolution	<ul style="list-style-type: none"> <li>12.1 in.: 1280 x 800 16:9 widescreen, 16.7M colors</li> <li>15.6 in. and 18.5 in.: 1366 x 768 16:9 widescreen, 16.7M colors</li> <li>21.5 in.: 1920 x 1080 16:9 widescreen, 16.7M colors</li> </ul>	<ul style="list-style-type: none"> <li>1550M: 1024 x 768, 16.7M colors</li> <li>1750M/1950M: 1280 x 1024, 16.7M colors</li> </ul>	<ul style="list-style-type: none"> <li>1200M: 800 x 600, 256K colors</li> <li>1500M: 1024 x 768, 16.7M colors</li> <li>1700M/1900M: 1280 x 1024, 16.7M colors</li> </ul>
Touch screen	Projected capacitive, 10-point multi-touch USB input	Resistive antiglare RS-232 and USB inputs, model dependent	Resistive antiglare RS-232 and USB inputs, model dependent
Contrast ratio	<ul style="list-style-type: none"> <li>12.1 in.: 1000:1</li> <li>15.6 in.: 500:1</li> <li>18.5 in.: 1000:1</li> <li>21.5 in.: 5000:1</li> </ul>	<ul style="list-style-type: none"> <li>1550M: 400:1</li> <li>1750M/1950M: 800:1</li> </ul>	<ul style="list-style-type: none"> <li>1200M: 600:1</li> <li>1500M: 400:1</li> <li>1700M: 1000:1</li> <li>1900M: 1300:1</li> </ul>
Luminance	<ul style="list-style-type: none"> <li>12.1 in.: 400 cd/m<sup>2</sup> (Nits)</li> <li>15.6 in.: 400 cd/m<sup>2</sup> (Nits)</li> <li>18.5 in.: 450 cd/m<sup>2</sup> (Nits)</li> <li>21.5 in.: 350 cd/m<sup>2</sup> (Nits)</li> </ul>	<ul style="list-style-type: none"> <li>1550M: 350 cd/m<sup>2</sup> (Nits)</li> <li>1750M/1950M: 300 cd/m<sup>2</sup> (Nits)</li> </ul>	<ul style="list-style-type: none"> <li>1500M/1700M: 450 cd/m<sup>2</sup> (Nits)</li> <li>1700M/1900M: 300 cd/m<sup>2</sup> (Nits)</li> </ul>
Video input signal	DisplayPort, DVI, VGA <sup>(1)</sup>	DVI and VGA (analog)	DVI and VGA (analog)
OS drivers, touch screen	<ul style="list-style-type: none"> <li>Windows</li> <li>Linux</li> </ul>	<ul style="list-style-type: none"> <li>Windows 10 IoT Enterprise<sup>(2)</sup></li> <li>Windows Embedded 8.1 Industry Pro<sup>(2)</sup></li> <li>Windows 7 Pro 64 bit<sup>(2)</sup></li> <li>Windows 7 Pro 32 bit<sup>(1)</sup></li> <li>Windows XP Pro<sup>(3)</sup></li> <li>Windows Server 2012 Standard R2<sup>(2)</sup></li> <li>Windows Server 2008<sup>(2)</sup></li> <li>Windows Server 2003<sup>(1)</sup></li> </ul>	<ul style="list-style-type: none"> <li>Windows 10 IoT Enterprise</li> <li>Windows Embedded 8.1 Industry Pro<sup>(4)</sup></li> <li>Windows 7 Pro 64 bit<sup>(4)</sup></li> <li>Windows 7 Pro 32 bit<sup>(3)</sup></li> <li>Windows XP Pro<sup>(5)</sup></li> <li>Windows Server 2012 Standard R2<sup>(4)</sup></li> <li>Windows Server 2008<sup>(4)</sup></li> <li>Windows Server 2003<sup>(3)</sup></li> </ul>
Power	DC	AC or DC	AC or DC
Environmental conditions			
Temperature	0...50 °C (32...122 °F)	0...45 °C (32...113 °F)	1200M/1500M: 0...55 °C (32...131 °F) 1700M/1900M: 0...50 °C (32...122 °F)
Shock (operating/nonoperating)	15 g/30 g	15 g/20 g	20 g/30 g
Vibration (operating/nonoperating)	1 g/2 g	1 g/2 g	2 g/2 g Rated Class 1 Division 2 for hazardous locations Preferred computer: 6181X hazardous location
Mount options	<ul style="list-style-type: none"> <li>Panel</li> <li>VESA</li> </ul>	<ul style="list-style-type: none"> <li>Panel</li> <li>VESA</li> <li>Bench/tabletop</li> <li>Rack (only 1900M)</li> </ul>	<ul style="list-style-type: none"> <li>Panel</li> <li>Bench/tabletop</li> <li>Rack (only 1900M)</li> </ul>

(1) For VGA, cat. no. 6189V-DVIVGA DVI-to-VGA adapter required, which is sold separately.

(2) For Series C or later monitors.

(3) For Series B or later monitors.

(4) For Series G or later monitors.

(5) For Series F or later monitors.

## VersaView 5100 Industrial Monitors

VersaView 5100 industrial monitors are designed for applications that require widescreen content. They have an edge-to-edge, all glass, 10-point multi-touch screen. The touch screens are precalibrated so that recalibration is not necessary. In addition, the stainless steel construction allows them to be used in NEMA 4X and IEC IP66 environments.

The native DisplayPort interface makes them ideal for connecting to VersaView 5000 computers and Thin Clients.



**Table 26 - Environmental Specifications, VersaView 5100 Industrial Monitors**

Attribute	6200M-12WBN, 6200M-15WBN, 6200M-19WBN, 6200M-22WBN
Temperature, operating	0...50 °C (32...122 °F)
Temperature, nonoperating	-20...+70 °C (-4...+158 °F)
Relative humidity	10...90% noncondensing
Vibration, operating	1 g at 10...500 Hz
Vibration, nonoperating	2 g at 10...500 Hz
Shock, operating	15 g (1/2 sine, 11 ms)
Shock, nonoperating	30 g (1/2 sine, 11 ms)
Enclosure ratings	<ul style="list-style-type: none"> <li>• VESA mount: IEC IP20</li> <li>• Panel mount: NEMA 4X, IEC IP66</li> </ul>

**Table 27 - Certifications, VersaView 5100 Industrial Monitors**

For the most current certification information, visit the Rockwell Automation Literature Library website at <https://www.rockwellautomation.com/global/literature-library/overview.page>. Use 6200-CT as your search criteria.

Certification	6200M-12WBN, 6200M-15WBN, 6200M-19WBN, 6200M-22WBN																																																																					
c-UL-us	For details, see <a href="#">6200-CT007</a> .																																																																					
CE	For details, see <a href="#">6200-CT002</a> .																																																																					
EAC	For details, see <a href="#">6200-CT005</a> .																																																																					
FCC	Class A emissions																																																																					
KC	For details, see <a href="#">6200-CT008</a> .																																																																					
RCM	For details, see <a href="#">6200-CT004</a> .																																																																					
RoHS	<p>European RoHS 2011/65/EU. For more details, see <a href="#">6200-CT007</a>.</p> <p>China RoHS:</p> <table border="1"> <thead> <tr> <th rowspan="2">部件名称 Part Name</th> <th colspan="6">有毒有害物质或元素 Toxic or Hazardous Substances and Elements</th> </tr> <tr> <th>铅 Lead (Pb)</th> <th>汞 Mercury (Hg)</th> <th>镉 Cadmium (Cd)</th> <th>六价铬 Hexavalent Chromium (Cr(VI))</th> <th>多溴联苯 Polybrominated Biphenyls (PBB)</th> <th>多溴二苯醚 Polybrominated Diphenyl Ethers (PBDE)</th> </tr> </thead> <tbody> <tr> <td>壳体 Housing</td> <td>X</td> <td>0</td> <td>0</td> <td>0</td> <td>0</td> <td>0</td> </tr> <tr> <td>显示 Display</td> <td>X</td> <td>0</td> <td>0</td> <td>0</td> <td>0</td> <td>0</td> </tr> <tr> <td>印刷电路板 Printed Circuit Board</td> <td>X</td> <td>0</td> <td>0</td> <td>0</td> <td>0</td> <td>0</td> </tr> <tr> <td>金属螺帽 Metal Fasteners</td> <td>X</td> <td>0</td> <td>0</td> <td>0</td> <td>0</td> <td>0</td> </tr> <tr> <td>电缆组装 Cable Assembly</td> <td>X</td> <td>0</td> <td>0</td> <td>0</td> <td>0</td> <td>0</td> </tr> <tr> <td>风扇组装 Fan Assembly</td> <td>X</td> <td>0</td> <td>0</td> <td>0</td> <td>0</td> <td>0</td> </tr> <tr> <td>电力供应组装 Power Supply Assemblies</td> <td>X</td> <td>0</td> <td>0</td> <td>0</td> <td>0</td> <td>0</td> </tr> <tr> <td>电池 Battery</td> <td>0</td> <td>0</td> <td>0</td> <td>0</td> <td>0</td> <td>0</td> </tr> </tbody> </table> <p>本表格依据SJ/T11364 的规定编制。 This table is made per guidance of SJ/T 11364.</p> <p>0: 表示该有害物质在该部件所有均质材料中的含量均在GB/T26572 规定的限量要求以下。 0: Indicates that this toxic or hazardous substance contained in all of the homogeneous materials for the part is below the limit requirement in GB/T 26572.</p> <p>X: 表示该有害物质至少在该部件的某一均质材料中的含量超出GB/T26572 规定的限量要求。 求。(企业可在此处,根据实际情况对上表中打“×”的技术原因进行进一步说明。) X: Indicates that this toxic or hazardous substance contained in at least one of the homogeneous materials for the part is below the limit requirement in GB/T 26572.</p> <p>Turkey RoHS (EEE Yönetmeliğine Uygundur. In Conformity with the EEE Regulation)</p>	部件名称 Part Name	有毒有害物质或元素 Toxic or Hazardous Substances and Elements						铅 Lead (Pb)	汞 Mercury (Hg)	镉 Cadmium (Cd)	六价铬 Hexavalent Chromium (Cr(VI))	多溴联苯 Polybrominated Biphenyls (PBB)	多溴二苯醚 Polybrominated Diphenyl Ethers (PBDE)	壳体 Housing	X	0	0	0	0	0	显示 Display	X	0	0	0	0	0	印刷电路板 Printed Circuit Board	X	0	0	0	0	0	金属螺帽 Metal Fasteners	X	0	0	0	0	0	电缆组装 Cable Assembly	X	0	0	0	0	0	风扇组装 Fan Assembly	X	0	0	0	0	0	电力供应组装 Power Supply Assemblies	X	0	0	0	0	0	电池 Battery	0	0	0	0	0	0
部件名称 Part Name	有毒有害物质或元素 Toxic or Hazardous Substances and Elements																																																																					
	铅 Lead (Pb)	汞 Mercury (Hg)	镉 Cadmium (Cd)	六价铬 Hexavalent Chromium (Cr(VI))	多溴联苯 Polybrominated Biphenyls (PBB)	多溴二苯醚 Polybrominated Diphenyl Ethers (PBDE)																																																																
壳体 Housing	X	0	0	0	0	0																																																																
显示 Display	X	0	0	0	0	0																																																																
印刷电路板 Printed Circuit Board	X	0	0	0	0	0																																																																
金属螺帽 Metal Fasteners	X	0	0	0	0	0																																																																
电缆组装 Cable Assembly	X	0	0	0	0	0																																																																
风扇组装 Fan Assembly	X	0	0	0	0	0																																																																
电力供应组装 Power Supply Assemblies	X	0	0	0	0	0																																																																
电池 Battery	0	0	0	0	0	0																																																																

**Table 28 - Technical Specifications, VersaView 5100 Industrial Monitors**

Attribute	6200M-12WBN	6200M-15WBN	6200M-19WBN	6200M-22WBN
Display type	Color active-matrix TFT LCD			
Display size, diagonal	12.1 in. (307 mm)	15.6 in. (396 mm)	18.5 in. (470 mm)	21.5 in. (546 mm)
Display area (W x H)	261.1 x 163.2 mm (10.28 x 6.43 in.)	344.2 x 193.5 mm (13.55 x 7.62 in.)	409.8 x 230.4 mm (16.13 x 9.07 in.)	476.6 x 268.1 mm (18.76 x 10.56 in.)
Resolution, native mode	1280 x 800	1366 x 768		1920 x 1080
Luminance	400 cd/m <sup>2</sup> (Nits)		450 cd/m <sup>2</sup> (Nits)	350 cd/m <sup>2</sup> (Nits)
Contrast ratio, typical	1000:1	500:1	1000:1	5000:1
Response time, max • Fall • Rise	• 4 ms • 9 ms		• 2.5 ms • 5 ms	• 10 ms • 25 ms
Status indicator backlight lifetime	100,000 hours at 25 °C (77 °F)	50,000 hours at 25 °C (77 °F)		
Backlight type	Light-emitting diode			
Bezel type	Tempered glass with stainless steel ring			
Touch screen	Projected capacitive (PCAP), 10-point multi-touch USB input			
Touch screen controller	EETI/eGalax			
OS drivers, touch screen	• Windows • Linux			
USB hub	None			
Video input connectors	• DisplayPort • DVI • VGA <sup>(1)</sup>			
OSD controls	Via software utility <sup>(2)</sup>			
Input voltage, DC	24V DC			
Power consumption, max	11.7 W	12.1 W	15.3 W	25.5 W
Dimensions, approx	See <a href="#">page 31</a> .			
Cutout dimensions				
Weight, approx	4.08 kg (9 lb)	5.39 kg (11.9 lb)	6.75 kg (14.9 lb)	7.98 kg (17.6 lb)
Mount options	• VESA 75/100 • Panel mount			

(1) Can be used for VGA with DVI-to-VGA adapter, cat. no. 6189V-DVIVGA, which is sold separately.

(2) Available for download from the Rockwell Automation Product Compatibility and Download Center (PCDC), <https://compatibility.rockwellautomation.com/Pages/home.aspx>.

**Figure 6 - VersaView 5100 Industrial Monitors Dimensions**

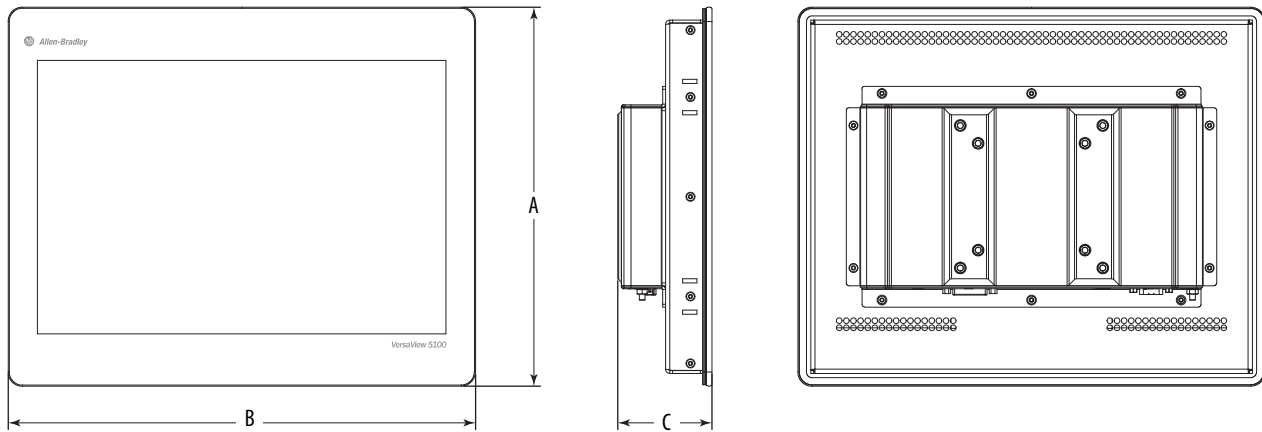

VersaView Model	All dimensions are in mm (in.)				
	Height A	Width B	Depth C	Cutout Height	Cutout Width
6200M-12WBN	266 (10.47)	328 (12.91)	66.1 (2.6)	250 (9.84)	312 (12.28)
6200M-15WBN	298 (11.73)	414 (16.3)		282 (11.1)	398 (15.67)
6200M-19WBN	337 (13.27)	480 (18.9)		321 (12.64)	464 (18.27)
6200M-22WBN	373 (14.68)	545 (21.46)		357 (14.06)	529 (20.83)

### 6186M Performance Industrial Monitors

The 6186M performance monitors are rated Class 1 Division 2 for hazardous locations to withstand extreme conditions. These monitors are best suited for special purpose environments like the food and beverage industries, since they provide excellent protection against heat, shock, and vibration.

Combine these monitors with Rockwell Automation non-display industrial computers for a powerful visualization and information computing solution.



Aluminum Bezel Model



Stainless Steel Bezel Model

**Table 29 - Environmental Specifications, 6186M Performance Industrial Monitors**

Attribute	1200M, 1500M, 1700M, 1900M
Temperature, operating	
1200M, 1500M	0...55 °C (32...131 °F)
1700M, 1900M	0...50 °C (32...122 °F)
Temperature, nonoperating	-20...+60 °C (-4...+140 °F)
Relative humidity	10...90% noncondensing
Vibration, operating	2 g at 10...640 Hz
Vibration, nonoperating	2 g at 10...640 Hz
Shock, operating	20 g (1/2 sine, 11 ms)
Shock, nonoperating	30 g (1/2 sine, 11 ms)
Enclosure ratings <sup>(1)</sup>	NEMA / UL 50 Type 1, 4, 4X, 12, and IEC IP66

(1) Applies only to panel-mounted monitors.

**Table 30 - Certifications, 6186M Performance Industrial Monitors**

For the most current certification information, visit the Rockwell Automation Literature Library website at <https://www.rockwellautomation.com/global/literature-library/overview.page>. Use 6186M-CT as your search criteria.

<b>Certification</b>	<b>1200M, 1500M, 1700M, 1900M</b>																																																																					
c-UL-us for use in hazardous locations	For details, see <a href="#">6186M-CT004</a> .																																																																					
CE	For details, see <a href="#">6186M-CT003</a> .																																																																					
KC	For details, see <a href="#">6186M-CT001</a> (17-in.) and <a href="#">6186M-CT002</a> (19-in.).																																																																					
RCM	Australian Radiocommunications Act, compliance with: AS/NZS 3548 (CISPR 22, EN55022)																																																																					
RoHS	<p>European RoHS 2011/65/EU. For more details, see <a href="#">6186M-CT003</a>.</p> <p>China RoHS:</p> <table border="1"> <thead> <tr> <th rowspan="2">部件名称 Part Name</th> <th colspan="6">有毒有害物质或元素 Toxic or Hazardous Substances and Elements</th> </tr> <tr> <th>铅 Lead (Pb)</th> <th>汞 Mercury (Hg)</th> <th>镉 Cadmium (Cd)</th> <th>六价铬 Hexavalent Chromium (Cr(VI))</th> <th>多溴联苯 Polybrominated Biphenyls (PBB)</th> <th>多溴二苯醚 Polybrominated Diphenyl Ethers (PBDE)</th> </tr> </thead> <tbody> <tr> <td>壳体 Housing</td> <td>X</td> <td>0</td> <td>0</td> <td>0</td> <td>0</td> <td>0</td> </tr> <tr> <td>显示 Display</td> <td>X</td> <td>0</td> <td>0</td> <td>0</td> <td>0</td> <td>0</td> </tr> <tr> <td>印刷电路板 Printed Circuit Board</td> <td>X</td> <td>0</td> <td>0</td> <td>0</td> <td>0</td> <td>0</td> </tr> <tr> <td>金属螺帽 Metal Fasteners</td> <td>X</td> <td>0</td> <td>0</td> <td>0</td> <td>0</td> <td>0</td> </tr> <tr> <td>电缆组装 Cable Assembly</td> <td>X</td> <td>0</td> <td>0</td> <td>0</td> <td>0</td> <td>0</td> </tr> <tr> <td>风扇组装 Fan Assembly</td> <td>X</td> <td>0</td> <td>0</td> <td>0</td> <td>0</td> <td>0</td> </tr> <tr> <td>电力供应组装 Power Supply Assemblies</td> <td>X</td> <td>0</td> <td>0</td> <td>0</td> <td>0</td> <td>0</td> </tr> <tr> <td>电池 Battery</td> <td>0</td> <td>0</td> <td>0</td> <td>0</td> <td>0</td> <td>0</td> </tr> </tbody> </table> <p>本表格依据SJ/T11364 的规定编制。 This table is made per guidance of SJ/T 11364.</p> <p>0: 表示该有害物质在该部件所有均质材料中的含量均在 GB/T26572 规定的限量要求以下。 0: Indicates that this toxic or hazardous substance contained in all of the homogeneous materials for the part is below the limit requirement in GB/T 26572.</p> <p>X: 表示该有害物质至少在该部件的某一均质材料中的含量超出GB/T26572 规定的限量要求。 求。(企业可在此处,根据实际情况对上表中打“×”的技术原因进行进一步说明。)</p> <p>X: Indicates that this toxic or hazardous substance contained in at least one of the homogeneous materials for the part is below the limit requirement in GB/T 26572.</p> <p>Turkey RoHS (EEE Yönetmeliğine Uygundur. In Conformity with the EEE Regulation)</p>	部件名称 Part Name	有毒有害物质或元素 Toxic or Hazardous Substances and Elements						铅 Lead (Pb)	汞 Mercury (Hg)	镉 Cadmium (Cd)	六价铬 Hexavalent Chromium (Cr(VI))	多溴联苯 Polybrominated Biphenyls (PBB)	多溴二苯醚 Polybrominated Diphenyl Ethers (PBDE)	壳体 Housing	X	0	0	0	0	0	显示 Display	X	0	0	0	0	0	印刷电路板 Printed Circuit Board	X	0	0	0	0	0	金属螺帽 Metal Fasteners	X	0	0	0	0	0	电缆组装 Cable Assembly	X	0	0	0	0	0	风扇组装 Fan Assembly	X	0	0	0	0	0	电力供应组装 Power Supply Assemblies	X	0	0	0	0	0	电池 Battery	0	0	0	0	0	0
部件名称 Part Name	有毒有害物质或元素 Toxic or Hazardous Substances and Elements																																																																					
	铅 Lead (Pb)	汞 Mercury (Hg)	镉 Cadmium (Cd)	六价铬 Hexavalent Chromium (Cr(VI))	多溴联苯 Polybrominated Biphenyls (PBB)	多溴二苯醚 Polybrominated Diphenyl Ethers (PBDE)																																																																
壳体 Housing	X	0	0	0	0	0																																																																
显示 Display	X	0	0	0	0	0																																																																
印刷电路板 Printed Circuit Board	X	0	0	0	0	0																																																																
金属螺帽 Metal Fasteners	X	0	0	0	0	0																																																																
电缆组装 Cable Assembly	X	0	0	0	0	0																																																																
风扇组装 Fan Assembly	X	0	0	0	0	0																																																																
电力供应组装 Power Supply Assemblies	X	0	0	0	0	0																																																																
电池 Battery	0	0	0	0	0	0																																																																



**Table 31 - Technical Specifications, 6186M Performance Industrial Monitors**

Attribute	1200M	1500M	1700M	1900M
Display type	Color active-matrix TFT LCD			
Display size, diagonal	12.1 in. (307 mm)	15 in. (381 mm)	17 in. (432 mm)	19 in. (483 mm)
Display area (WxH)	246 x 185 mm (9.7 x 7.3 in.)	305 x 229 mm (12 x 9 in.)	338 x 270 mm (13.3 x 10.6 in.)	377 x 302 mm (14.8 x 11.9 in.)
Resolution, native mode	800 x 600 262K colors	1024 x 768 16.2M colors	1280 x 1024 16.7M colors	
Luminance	450 cd/m <sup>2</sup> Nits		300 cd/m <sup>2</sup> Nits	
Contrast ratio	600:1, typical	400:1, typical	1000:1, typical	1300:1, typical
Response time, max	35 ms	16 ms	8 ms	
Status indicator backlight lifetime	50,000 hours at 25 °C (77 °F)			
Bezel	Aluminum	<ul style="list-style-type: none"> <li>Aluminum</li> <li>Stainless steel</li> </ul>		
Touch screen option	Resistive antiglare (RS-232 and USB inputs), model dependent			
OS drivers, touch screen	<ul style="list-style-type: none"> <li>Windows 10 IoT Enterprise</li> <li>Windows Embedded 8.1 Industry Pro<sup>(2)</sup></li> <li>Windows 7 Pro 64 bit<sup>(1)</sup></li> <li>Windows 7 Pro 32 bit<sup>(1)</sup></li> <li>Windows XP Pro<sup>(2)</sup></li> <li>Windows Server 2012 Standard R2<sup>(2)</sup></li> <li>Windows Server 2008<sup>(2)</sup></li> <li>Windows Server 2003<sup>(1)</sup></li> </ul>			
USB hub	(2) rear USB 2.0 ports, 500 mA per port (1) front USB 2.0 port, 500 mA (only on aluminum bezel models)			
Video input signal	DVI and VGA			
Video input connectors	HD-15 VGA for analog video signal DVI for digital video signal			
OSD controls (on rear)	<ul style="list-style-type: none"> <li>Automatic screen setup (OSD)</li> <li>Brightness</li> <li>Contrast</li> <li>Horizontal position</li> <li>Vertical position</li> <li>Image lock</li> <li>Color balance</li> <li>Sync detect</li> </ul>			
Input voltage, AC	100...240V AC autoranging, 47...63 Hz, requires power adapter			
Power consumption, max	34 W	34 W	55 W	57 W
Input voltage, DC	9...36V DC (24V DC nominal)			
Weight, approx	4.4 kg (9.75 lb)	<ul style="list-style-type: none"> <li>Aluminum: 7.3 kg (16.0 lb)</li> <li>Stainless steel: 8.6 kg (19.0 lb)</li> </ul>	<ul style="list-style-type: none"> <li>Aluminum: 8.6 kg (19.0 lb)</li> <li>Stainless steel: 10.1 kg (22.25 lb)</li> </ul>	<ul style="list-style-type: none"> <li>Aluminum: 10.2 kg (22.5 lb)</li> <li>Stainless steel: 11.9 kg (26.25 lb)</li> </ul>
Dimensions, approx	See <a href="#">Figure 7</a> on <a href="#">page 34</a> .			
Cutout dimensions				
Mount options	<ul style="list-style-type: none"> <li>Panel</li> <li>Bench/tabletop</li> <li>DIN rail for AC power adapter</li> </ul>			<ul style="list-style-type: none"> <li>Panel</li> <li>Bench/tabletop</li> <li>DIN rail for AC power adapter</li> </ul>

(1) For Series G or later monitors.

(2) For Series F or later monitors.

**Figure 7 - 6186M Performance Industrial Monitor Dimensions**

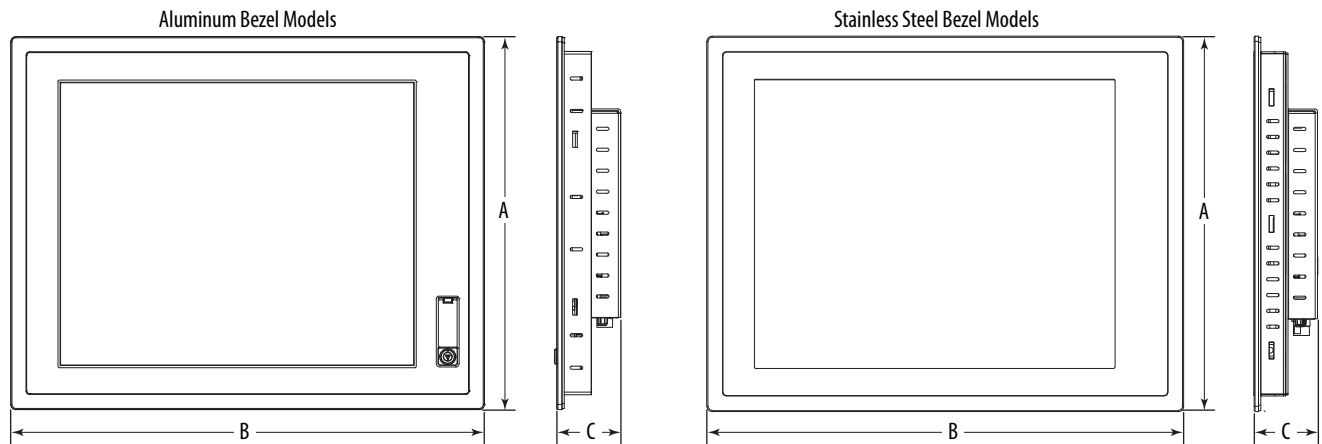

6186M Model	All dimensions are in mm (in.)				
	Height A	Width B	Depth C	Cutout Height	Cutout Width
1200M	260 (10.24)	340 (13.39)	61 (2.40)	238 (9.37)	318 (12.51)
1500M	309 (12.17)	410 (16.14)		285.6 (11.24)	386.6 (15.22)
1700M	356 (14.02)	452 (17.80)		329.5 (12.97)	424 (16.69)
1900M	399 (15.71)	483 (19.02)	64 (2.52)	363.5 (14.31)	449.6 (17.7)

### 6176M Standard Industrial Monitors

The 6176M standard monitors are designed for less demanding environments, still providing industrial ratings for temperature, shock, and vibration.

**Table 32 - Technical Specifications, 6176M Standard Industrial Monitors**

Attribute	1550M, 1750M, 1950M
Temperature, operating	0...45 °C (32...113 °F)
Temperature, nonoperating	-20...+60 °C (-4...+140 °F)
Relative humidity	10...90% noncondensing
Vibration, operating	1 g at 53...640 Hz
Vibration, nonoperating	2 g at 53...640 Hz
Shock, operating	15 g (1/2 sine, 11 ms)
Shock, nonoperating	20 g (1/2 sine, 11 ms)
Enclosure ratings <sup>(1)</sup>	NEMA Type 4, 12, IEC IP66

(1) Applies only to panel-mounted monitors.

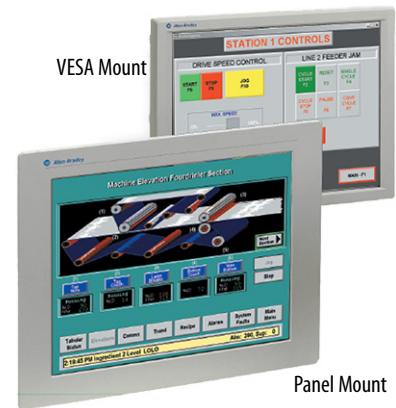

**Table 33 - Certifications, 6176M Standard Industrial Monitors**

For the most current certification information, visit the Rockwell Automation Literature Library website at <https://www.rockwellautomation.com/global/literature-library/overview.page>. Use 6176M-CT as your search criteria.

Certification	1550M, 1750M, 1950M																																																																					
UL/c-UL	For details, see <a href="#">6176M-CT004</a> .																																																																					
CE	For details, see <a href="#">6176M-CT003</a> .																																																																					
KCC	For details, see <a href="#">6176M-CT001</a> .																																																																					
RoHS	<p>2011/65/EU European RoHS. For more details, see <a href="#">6176M-CT003</a>. China RoHS:</p> <table border="1"> <thead> <tr> <th rowspan="2">部件名称 Part Name</th> <th colspan="6">有毒有害物质或元素 Toxic or Hazardous Substances and Elements</th> </tr> <tr> <th>铅 Lead (Pb)</th> <th>汞 Mercury (Hg)</th> <th>镉 Cadmium (Cd)</th> <th>六价铬 Hexavalent Chromium (Cr(VI))</th> <th>多溴联苯 Polybrominated Biphenyls (PBB)</th> <th>多溴二苯醚 Polybrominated Diphenyl Ethers (PBDE)</th> </tr> </thead> <tbody> <tr> <td>壳体 Housing</td> <td>X</td> <td>0</td> <td>0</td> <td>0</td> <td>0</td> <td>0</td> </tr> <tr> <td>显示 Display</td> <td>X</td> <td>0</td> <td>0</td> <td>0</td> <td>0</td> <td>0</td> </tr> <tr> <td>印刷电路板 Printed Circuit Board</td> <td>X</td> <td>0</td> <td>0</td> <td>0</td> <td>0</td> <td>0</td> </tr> <tr> <td>金属螺帽 Metal Fasteners</td> <td>X</td> <td>0</td> <td>0</td> <td>0</td> <td>0</td> <td>0</td> </tr> <tr> <td>电缆组装 Cable Assembly</td> <td>X</td> <td>0</td> <td>0</td> <td>0</td> <td>0</td> <td>0</td> </tr> <tr> <td>风扇组装 Fan Assembly</td> <td>X</td> <td>0</td> <td>0</td> <td>0</td> <td>0</td> <td>0</td> </tr> <tr> <td>电力供应组装 Power Supply Assemblies</td> <td>X</td> <td>0</td> <td>0</td> <td>0</td> <td>0</td> <td>0</td> </tr> <tr> <td>电池 Battery</td> <td>0</td> <td>0</td> <td>0</td> <td>0</td> <td>0</td> <td>0</td> </tr> </tbody> </table> <p>本表格依据SJ/T11364 的规定编制。 This table is made per guidance of SJ/T 11364.</p> <p>0: 表示该有害物质在该部件所有均质材料中的含量均在GB/T26572 规定的限量要求以下。 0: Indicates that this toxic or hazardous substance contained in all of the homogeneous materials for the part is below the limit requirement in GB/T 26572.</p> <p>X: 表示该有害物质至少在该部件的某一均质材料中的含量超出GB/T26572 规定的限量要求。 求。(企业可在此处, 根据实际情况对上表中打“X”的技术原因进行进一步说明。) X: Indicates that this toxic or hazardous substance contained in at least one of the homogeneous materials for the part is below the limit requirement in GB/T 26572.</p> <p>Turkey RoHS (EEE Yönetmeliğine Uygundur. In Conformity with the EEE Regulation)</p>	部件名称 Part Name	有毒有害物质或元素 Toxic or Hazardous Substances and Elements						铅 Lead (Pb)	汞 Mercury (Hg)	镉 Cadmium (Cd)	六价铬 Hexavalent Chromium (Cr(VI))	多溴联苯 Polybrominated Biphenyls (PBB)	多溴二苯醚 Polybrominated Diphenyl Ethers (PBDE)	壳体 Housing	X	0	0	0	0	0	显示 Display	X	0	0	0	0	0	印刷电路板 Printed Circuit Board	X	0	0	0	0	0	金属螺帽 Metal Fasteners	X	0	0	0	0	0	电缆组装 Cable Assembly	X	0	0	0	0	0	风扇组装 Fan Assembly	X	0	0	0	0	0	电力供应组装 Power Supply Assemblies	X	0	0	0	0	0	电池 Battery	0	0	0	0	0	0
部件名称 Part Name	有毒有害物质或元素 Toxic or Hazardous Substances and Elements																																																																					
	铅 Lead (Pb)	汞 Mercury (Hg)	镉 Cadmium (Cd)	六价铬 Hexavalent Chromium (Cr(VI))	多溴联苯 Polybrominated Biphenyls (PBB)	多溴二苯醚 Polybrominated Diphenyl Ethers (PBDE)																																																																
壳体 Housing	X	0	0	0	0	0																																																																
显示 Display	X	0	0	0	0	0																																																																
印刷电路板 Printed Circuit Board	X	0	0	0	0	0																																																																
金属螺帽 Metal Fasteners	X	0	0	0	0	0																																																																
电缆组装 Cable Assembly	X	0	0	0	0	0																																																																
风扇组装 Fan Assembly	X	0	0	0	0	0																																																																
电力供应组装 Power Supply Assemblies	X	0	0	0	0	0																																																																
电池 Battery	0	0	0	0	0	0																																																																
RCM	For details, see <a href="#">6176M-CT002</a> .																																																																					

**Table 34 - Technical Specifications, 6176M Standard Industrial Monitors**

Attribute	1550M	1750M	1950M	
Display type	Color active-matrix TFT LCD			
Display size, diagonal	15 in. (381 mm)	17 in. (432 mm)	19 in. (483 mm)	
Display area (WxH)	305 x 229 mm (12.0 x 9.0 in.)	338 x 270 mm (13.3 x 10.7 in.)	377 x 302 mm (14.8 x 11.9 in.)	
Resolution	1024 x 768, 16.7M colors	1280 x 1024, 16.7M colors		
Luminance	350 cd/m <sup>2</sup> Nits			
Contrast ratio, typical	400:1	800:1		
Response time, max	4 ms (fall) 12 ms (rise)	3 ms (fall) 6 ms (rise)		
Status indicator backlight lifetime	50,000 hours at 25 °C (77 °F)			
Available bezels	<ul style="list-style-type: none"> <li>• Plastic (reinforced steel)</li> <li>• Aluminum alloy</li> </ul>			
Touch screen option	Resistive antiglare (RS-232 and USB inputs), model dependent			
Touch screen controller	Series A and B Series C PANJIT eGalax_eMPIA Technology Inc (EETI)			
OS drivers, touch screen	Series A and B Series C <ul style="list-style-type: none"> <li>• Windows 7 Pro (32 bit)</li> <li>• Windows XP Pro</li> <li>• Windows Server 2003 (32 bit)</li> <li>• Windows 10 IoT Enterprise</li> <li>• Windows Embedded 8.1 Industry Pro</li> <li>• Windows 7 Pro (32 bit and 64 bit)</li> <li>• Windows XP Pro</li> <li>• Windows Server 2012 Standard R2</li> <li>• Windows Server 2008 (64 bit)</li> <li>• Windows Server 2003 (32 bit)</li> </ul>			
USB hub	(2) USB 2.0, 500 mA per port			
Video input signal	VGA and DVI (system auto-select)			
Video input connectors	HD-15 VGA for analog video signal DVI for digital video signal			
OSD controls	Rear controls: automatic screen setup (OSD), brightness, contrast, horizontal position, vertical position, image lock, color balance, sync detect			
Input voltage, AC	90...264V AC autoranging, 47...63 Hz			
Power consumption	2.0 A at 24 W	3 A at 36 W	3.5 A at 42 W	
Input voltage, DC	12V DC, power adapter required			
Weight, approx	VESA mount Panel mount	3.1 kg (6.82 lb) 4.1 kg (9.02 lb)	4.6 kg (10.12 lb) 5.7 kg (12.54 lb)	6.0 kg (13.20 lb) 7.5 kg (16.50 lb)
Dimensions, approx	See <a href="#">Figure 8</a> on <a href="#">page 37</a> .			
Cutout dimensions				
Mount options	<ul style="list-style-type: none"> <li>• VESA</li> <li>• Panel</li> <li>• Bench/tabletop</li> </ul>	<ul style="list-style-type: none"> <li>• VESA</li> <li>• Panel</li> <li>• Bench/tabletop</li> </ul>	<ul style="list-style-type: none"> <li>• VESA</li> <li>• Panel</li> <li>• Rack<sup>(1)</sup></li> <li>• Bench/tabletop</li> </ul>	

(1) Installs in a standard 19-in. rack.

**Figure 8 - 6176M Standard Industrial Monitor Dimensions**

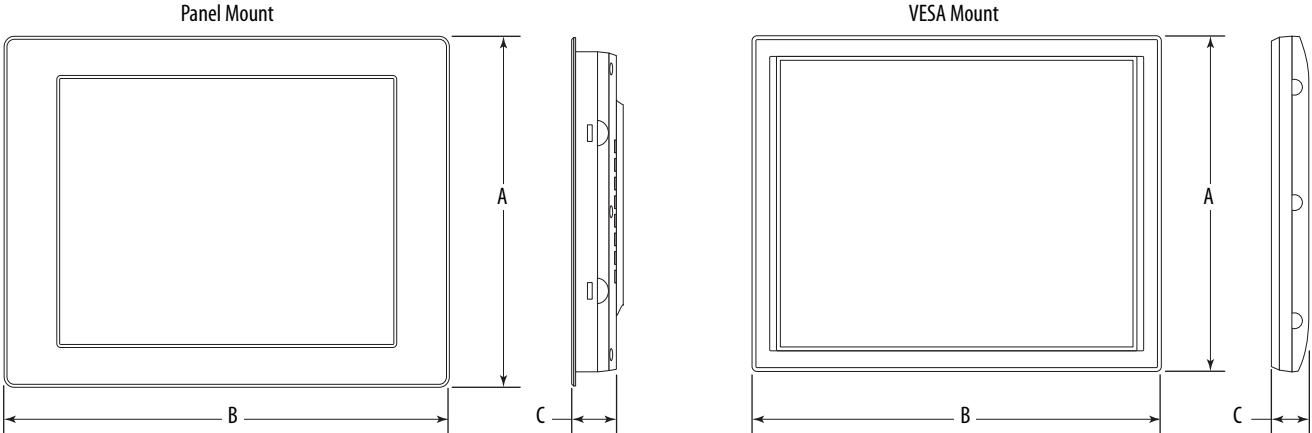

6176M Model	All dimensions are in mm (in.)				
	Height A	Width B	Depth C	Cutout Height	Cutout Width
<b>1550M</b>					
Panel mount	309 (12.3)	410 (16.1)	50 (2)	285.6 (11.24)	386.6 (15.22)
VESA mount	282.6 (11)	383.6 (15)		—	—
<b>1750M</b>					
Panel mount	356 (14)	452 (17.8)	53 (2.1)	329.5 (12.97)	424 (16.69)
VESA mount	326.5 (12.9)	421 (16.6)		—	—
<b>1950M</b>					
Panel mount	399.3 (15.7)	482.6 (19)	58 (2.3)	363.5 (14.31)	449.6 (17.7)
VESA mount	357 (14.1)	444 (17.5)		—	—

## HMI Software

The Allen-Bradley industrial computers support the full suite of Rockwell Software solutions, including Integrated Architecture and FactoryTalk View software. Combine this hardware and software to help assure comprehensive application support from an industry leader.

FactoryTalk View performance and visibility HMI software are designed with a common look, feel, and navigation to help speed HMI development and training time. The visualization strategy combines Rockwell Automation expertise in industrialized personal computer hardware with Rockwell Software supervisory control software.

For a complete list of available HMI software, visit <https://www.rockwellautomation.com/rockwellsoftware/overview.page>.

## FactoryTalk View Machine Edition Software

FactoryTalk View Machine Edition (ME) software supports both open and embedded operator interface solutions for monitoring and controlling individual machines or small processes. This software features a consistent operator interface across multiple platforms, including Microsoft® Windows® 10, 8.1, 8, 7, Server, and Embedded Compact solutions. FactoryTalk View ME software consists of a design and runtime environment.

### *FactoryTalk View Studio Software*

FactoryTalk View Studio software is the design environment to create and test HMI applications, including graphic displays, trends, alarms, and real time animation. Runtime files can be generated to run on a PanelView™ Plus terminal or industrial computer.

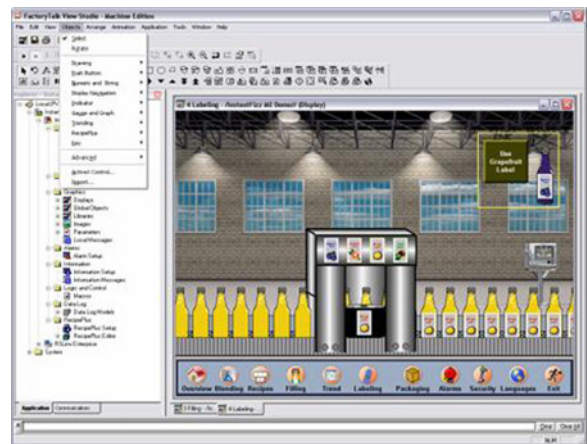

### *FactoryTalk View ME Station*

FactoryTalk View ME Station is the runtime environment for HMI applications. FactoryTalk View ME Station is automatically installed and activated on PanelView Plus terminals. FactoryTalk View ME activation is required when running HMI applications on industrial computers.

FactoryTalk View ME offers many advantages:

- Alarms to alert operators to conditions that require immediate action
- Security to restrict operator access to specific displays
- RecipePlus for machine or process recipe management
- Display text supports up to 20 languages per application, so operators can switch language at runtime
- Global and predefined objects are time and memory savers
- Studio 5000® and Logix Designer process faceplates
- Ability to convert runtime application to design application
- Transfer parameters for reuse in displays and design efficiency

## FactoryTalk View Site Edition Software

FactoryTalk View Site Edition (SE) software is used to develop and run supervisory-level monitoring and to control HMI applications. Its architecture is scalable to a wide range of applications, from standalone, one-server/one-client applications to multi-server/multi-client applications. Runtime servers and clients are supported for customers to develop and deploy a multi-server/multi-client application.

FactoryTalk View SE applications are created and tested within the FactoryTalk View Studio design environment:

- Share data and seamless integration with other FactoryTalk enabled products. The FactoryTalk Services Platform provides common services, such as security, alarms, and diagnostics across products.
- Optimize plant communication with FactoryTalk Live Data and premier connectivity to Allen-Bradley controllers.
- Access tag information directly in the controller to eliminate HMI tags.
- Configure an application from anywhere on the network to change a running system with a remote, multi-user configuration capability.
- Define graphic displays once and reference them throughout a distributed system.
- Provide an audit trail of operator and alarm information in a centralized log database.
- Customize the operator experience by using client-side VBA and the exposed graphics object model.



## FactoryTalk View Studio Enterprise Software

FactoryTalk View Studio Enterprise software is a design environment where you can create applications in both FactoryTalk View ME and FactoryTalk View SE software. The ability to edit and reuse projects in FactoryTalk View Studio improves portability between embedded machine and supervisory HMI systems.

With FactoryTalk View software, all products in the suite are built on the same integrated, scalable architecture. Application developers can import entire machine-level applications into supervisory-level applications or drag individual components and drop them right into supervisory projects, which saves development time and reduces engineering and training costs.

Plus, help protect your current HMI investments by importing PanelBuilder®32 (PanelView™) applications into FactoryTalk View ME software and RSVIEW®32 applications into FactoryTalk View SE software.

With FactoryTalk View Studio software, you can do the following:

- Configure one operator station or an entire distributed application from one location.
- Access tags from OPC servers throughout the system via a tag browser that presents direct controller tags and HMI tags in a logical hierarchy.
- Remotely configure RSLinx® and FactoryTalk View SE servers.
- Create displays by using a full-featured graphics editor.
- Define display text in multiple languages, so operators can switch language at runtime.
- Use pre-engineered faceplates to interface with the process control functions in the Logix controllers.

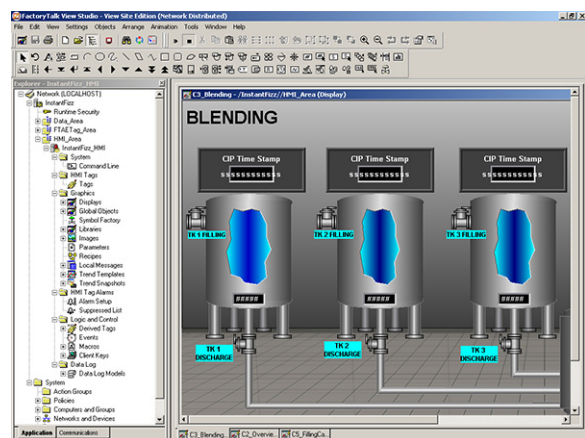

### FactoryTalk ViewPoint Software

An add-on to FactoryTalk View SE software and PanelView Plus 6 or 7 terminals, FactoryTalk ViewPoint software provides on-demand access to important information about your plant or process from a web browser. Plant managers, supervisors, OEMs, system integrators, and other key stakeholders can now access, monitor, and interact with plant floor operations from virtually any location. The thin-client configuration means no client software to install and maintain, which lowers total cost of ownership:

- Fully scalable, animated web applications viewable in the office, at home, or on the road.
- Gives managers, OEMs, and system integrators read and write capability to both view and control real time plant floor operations by logging in to an Internet browser.
- Provides read and write capabilities to monitor operations.
- Gain fast access to real time information with a standard web browser.
- Supports multiple browsers and client devices for increased flexibility.
- Lets FactoryTalk View projects be web-enabled without any necessary application changes.
- Monitor and control HMI applications, perform diagnostics, and provide remote support.

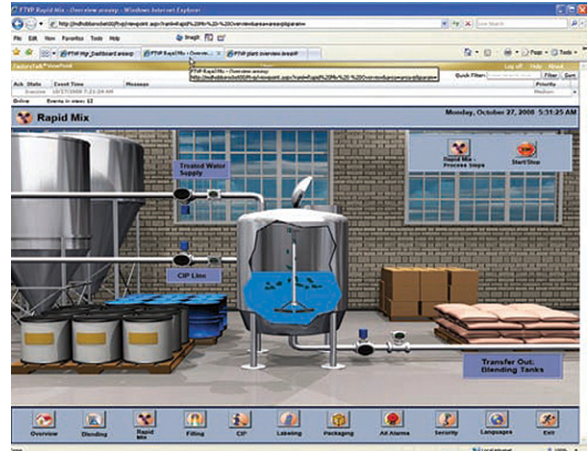

## Software Comparison

Table 35 - Software Technology

Customer Requirements	FactoryTalk View Site Edition (SE)	FactoryTalk View Machine Edition (ME)	RSView32
Operating systems (32 bit) <sup>(1)</sup>	<ul style="list-style-type: none"> <li>• Windows 10<sup>(2)</sup></li> <li>• Windows 7 SP1<sup>(2)</sup></li> </ul>		<ul style="list-style-type: none"> <li>• Windows 7 Professional</li> <li>• Windows Server 2008 Standard SP2</li> <li>• Windows Server 2000 SP4</li> <li>• Windows 2000 Professional SP4</li> </ul>
Operating systems (64 bit) <sup>(1)</sup>	<ul style="list-style-type: none"> <li>• Windows Server 2016<sup>(2)</sup></li> <li>• Windows Server 2012 R2<sup>(2)</sup></li> <li>• Windows Server 2008 R2<sup>(2)</sup></li> <li>• Windows 10<sup>(2)</sup></li> <li>• Windows 7 SP1<sup>(2)</sup></li> </ul>		
Embedded platforms		✓	
Windows domain security	✓	✓	✓
OPC/ActiveX	✓	✓	✓
FactoryTalk enabled	✓	✓	
Server-side VBA			✓
Client-side VBA	✓		

(1) Windows Vista, Windows XP Professional, and Windows Server 2003 are no longer supported with FactoryTalk View versions 8.20 or later.

(2) For the latest operating system information, visit the Rockwell Automation Product Compatibility and Download Center: <https://compatibility.rockwellautomation.com/Pages/MultiProductSelector.aspx?crumb=111>.



**Table 36 - Software Architecture**

Customer Requirements	FactoryTalk View SE		FactoryTalk View ME	RSView32
Primary application	Supervisory level: single station up to multiple server, multiple client		Machine level: single station	Supervisory level; single station up to single server, multiple client
Tag-based HMI	√		√	√
Direct reference capability	√		√	
	Network (Distributed)	Local		
Number of servers/clients, max	10/120 <sup>(1)</sup>			1/20
FactoryTalk ViewPoint	√	√	√ <sup>(2)</sup>	
RSView32 WebServer				√
Thin clients (terminal services)	√			√
Multi-user development	√			
Remote configuration at runtime	√			
Redundancy - data server	√			
Redundancy - HMI server	√			Active display

(1) Applies to FactoryTalk View SE software version 11; version 10 supports up to 80 clients.

(2) Supported only on PanelView Plus 6 and PanelView Plus 7 terminals.

**Table 37 - Software Features**

Customer Requirements	FactoryTalk View SE	FactoryTalk View ME	RSView32
Animation - visibility, color, fill, horizontal and vertical position, width, height, rotation, horizontal and vertical slider, and more	And touch	No touch animation	And touch
Alarms	<ul style="list-style-type: none"> <li>FactoryTalk alarms and events</li> <li>HMI alarms<sup>(1)</sup></li> <li>Digital and analog</li> <li>Defined alarm severities</li> <li>Alarm log</li> </ul>	<ul style="list-style-type: none"> <li>Tag-based (from controller)</li> <li>Alarm log</li> </ul>	<ul style="list-style-type: none"> <li>Tag-based</li> <li>Digital and analog</li> <li>Definable alarm severities</li> <li>Alarm log</li> </ul>
Data logging	<ul style="list-style-type: none"> <li>20 data log models per project</li> <li>Each with up to 10,000 tags</li> <li>Log to ODBC or proprietary database</li> </ul>	<ul style="list-style-type: none"> <li>1 data log model per project</li> <li>With up to 100 tags</li> <li>1,000K records max</li> <li>Export to dbf</li> </ul>	<ul style="list-style-type: none"> <li>20 plus data log models per project</li> <li>Each with up to 10,000 tags</li> <li>Log to ODBC or proprietary database</li> </ul>
Recipe support	Basic recipe functionality with RecipePro+	Recipe+	RecipePro extension
Trend support	<ul style="list-style-type: none"> <li>TrendX 4.0</li> <li>TrendPro+</li> </ul>	TrendX 4.0 subset	TrendX 3.1 and native
Security	<ul style="list-style-type: none"> <li>Assigned to tags, graphic displays, macros, commands, OLE objects</li> <li>Local or Windows security</li> </ul>	<ul style="list-style-type: none"> <li>Display-based</li> <li>Local or Windows security</li> </ul>	<ul style="list-style-type: none"> <li>Assigned to tags, graphic displays, macros, commands, OLE objects</li> <li>Local or Windows security</li> </ul>
Other features	<ul style="list-style-type: none"> <li>Test run macros</li> <li>Derived tags</li> <li>Event detector</li> </ul>	<ul style="list-style-type: none"> <li>Test run macros</li> <li>Derived tags</li> <li>S/B test run macros-derived tags</li> <li>Onboard audit trail<sup>(2)</sup></li> </ul>	<ul style="list-style-type: none"> <li>Test run macros</li> <li>Derived tags</li> <li>Event detector</li> </ul>
Price model	<ul style="list-style-type: none"> <li>Display-based</li> <li>Multiple levels</li> </ul>	<ul style="list-style-type: none"> <li>Included with PanelView Plus 7<sup>(2)</sup> or display-based</li> <li>Multiple levels for FactoryTalk View ME Station</li> </ul>	<ul style="list-style-type: none"> <li>Tag-based</li> <li>Multiple levels</li> </ul>

(1) FactoryTalk View SE software version 11 does not support HMI alarms but version 10 does.

(2) For applications that require regulatory compliance. Applies only to FactoryTalk View ME versions 10 or higher that are running on PanelView Plus 7 terminals.

**Table 38 - FactoryTalk View Site Edition (SE) Software**

Installation Type	Software Installed	Hardware Requirements (min)
Operator workstation	FactoryTalk View SE Client or FactoryTalk View SE Station	<ul style="list-style-type: none"> <li>Intel Core 2 Duo</li> <li>2 GB memory</li> </ul>
Engineering workstation	<ul style="list-style-type: none"> <li>FactoryTalk View Studio Enterprise</li> <li>RSLinX® Classic</li> <li>FactoryTalk Linx</li> <li>Studio 5000</li> </ul>	<ul style="list-style-type: none"> <li>Intel Core 2 Duo</li> <li>4 GB memory</li> </ul>
Application server	<ul style="list-style-type: none"> <li>FactoryTalk View SE Server</li> <li>FactoryTalk View Studio Enterprise</li> <li>FactoryTalk View Alarms and Tags based Server</li> <li>FactoryTalk Linx Data Server with FactoryTalk Alarms and Events enabled</li> </ul>	Smaller system: <ul style="list-style-type: none"> <li>Intel Core 2 Duo</li> <li>2 GB memory</li> </ul> Medium to larger systems: <ul style="list-style-type: none"> <li>Intel® Xeon® quad core</li> <li>4 GB memory</li> </ul>

**Table 39 - FactoryTalk View SE Software**

Media Cat. No.	Electronic Download Cat. No.	Description <sup>(1)</sup>
To choose your preferred language, replace the xx in the catalog number with EN for English, DE for German, FR for French, JP for Japanese, or ZH for Chinese.		
9701-VWSTxxM	9701-VWSTxxE	FactoryTalk View Studio for FactoryTalk View Enterprise - configuration software to develop and test machine level and supervisory level HMI applications
9701-VWSCWAxxM	9701-VWSCWAxxE	FactoryTalk View SE Client - software to view and interact with FactoryTalk View SE Servers <sup>(2)</sup>
9701-VWSCRAxxM	9701-VWSCRAxxE	FactoryTalk View SE View Client - provides read-only capabilities
9701-VWSB015AxxM	9701-VWSB015AxxE	FactoryTalk View SE Station 15 display
9701-VWSB025AxxM	9701-VWSB025AxxE	FactoryTalk View SE Station 25 display
9701-VWSB100AxxM	9701-VWSB100AxxE	FactoryTalk View SE Station 100 display
9701-VWSB250AxxM	9701-VWSB250AxxE	FactoryTalk View SE Station 250 display
9701-VWSB000AxxM	9701-VWSB000AxxE	FactoryTalk View SE Station unlimited display
9701-VWSS025LxxM	9701-VWSS025LxxE	FactoryTalk View SE Server 25 display with FactoryTalk Linx
9701-VWSS100LxxM	9701-VWSS100LxxE	FactoryTalk View SE Server 100 display with FactoryTalk Linx
9701-VWSS250LxxM	9701-VWSS250LxxE	FactoryTalk View SE Server 250 display with FactoryTalk Linx
9701-VWSS000LxxM	9701-VWSS000LxxE	FactoryTalk View SE Server unlimited display with FactoryTalk Linx

(1) FactoryTalk View SE Station and FactoryTalk View SE Server versions 11 include FactoryTalk Services version 6.10.00 (CPR9 SR11).

(2) FactoryTalk View SE Server stores HMI project components and serves to clients, for example, graphic displays.

**Table 40 - FactoryTalk ViewPoint Software**

Media Cat. No. <sup>(1)</sup>	Electronic Download Cat. No.	Description <sup>(2)</sup>
9522-VWP01RENM	9522-VWP01RENE	FactoryTalk ViewPoint 1-client system
9522-VWP03RENM	9522-VWP03RENE	FactoryTalk ViewPoint 3-client system
9522-VWP05RENM	9522-VWP05RENE	FactoryTalk ViewPoint 5-client system
9522-VWP10RENM	9522-VWP10RENE	FactoryTalk ViewPoint 10-client system
9522-VWP25RENM	9522-VWP25RENE	FactoryTalk ViewPoint 25-client system
9522-VWP50RENM	9522-VWP50RENE	FactoryTalk ViewPoint 50-client system

(1) Order any of these catalog numbers to use FactoryTalk ViewPoint software with FactoryTalk View SE network or local applications.

(2) FactoryTalk ViewPoint server and one client access license are included with the purchase of a PanelView Plus 6 or PanelView Plus 7 terminal. No other catalog numbers are required to use FactoryTalk ViewPoint software with PanelView Plus 6 or PanelView Plus 7 terminals.

**Table 41 - FactoryTalk View Machine Edition (ME) Software**

Media Cat. No.	Electronic Download Cat. No.	Description
To choose your preferred language, replace the xx in the catalog number with EN for English, DE for German, FR for French, JP for Japanese, or ZH for Chinese.		
9701-VWSTMxxM	9701-VWSTMxxE	FactoryTalk View Studio for Machine Edition - configuration software to develop and test machine level HMI applications. FactoryTalk View Machine Edition includes FactoryTalk Linx and KEPServer Enterprise software.

**Table 42 - FactoryTalk View ME Station**

Media Cat. No.	Electronic Download Cat. No.	Description <sup>(1) (2)</sup>
To choose your preferred language, replace the xx in the catalog number with EN for English, DE for German, FR for French, JP for Japanese, or ZH for Chinese.		
9701-VWMMR015AxxM	9701-VWMMR015AxxE	FactoryTalk View ME Station Runtime 15 displays
9701-VWMMR030AxxM	9701-VWMMR030AxxE	FactoryTalk View ME Station Runtime 30 displays
9701-VWMMR075AxxM	9701-VWMMR075AxxE	FactoryTalk View ME Station Runtime 75 displays
9701-VWMMR250AxxM	9701-VWMMR250AxxE	FactoryTalk View ME Station Runtime 250 displays
9701-VWMMR500AxxM	9701-VWMMR500AxxE	FactoryTalk View ME Station Runtime 500 displays

(1) FactoryTalk View ME Station is the runtime environment where FactoryTalk View ME projects created with FactoryTalk View Studio software are run on any computer with a Windows operating system. See [page 40](#) for the available Windows operating systems.

(2) FactoryTalk View ME Station runtime is included with all PanelView Plus 6 or PanelView Plus 7 terminals.

**Table 43 - Third-party Connectivity**

Media Cat. No.	Electronic Download Cat. No.	Description
9301-OPCSRVENM	9301-OPCSRVE	KEPServer Enterprise for RSVIEW32, FactoryTalk View Site Edition, and FactoryTalk View Machine Edition

## Additional Resources

These documents contain more information about related products from Rockwell Automation.

Resource	Description
Visualization Solutions Selection Guide, publication <a href="#">VIEW-SG001</a>	Provides an overview of the visualization products, which includes catalog number selections offered by Rockwell Automation.
VersaView 5000 Thin Clients and Industrial Computers User Manual, publication <a href="#">6200-UM001</a>	Provides information to install, make connections, operate, and troubleshoot VersaView Thin Clients, and integrated display and non-display industrial computers.
Integrated Display Industrial Computers User Manual, publication <a href="#">6181P-UM003</a>	Provides information to install, make connections, operate, and troubleshoot the 6181P integrated display and non-display computers with hard disk drives.
Integrated Display and Non-display Industrial Computers User Manual, publication <a href="#">6181P-UM004</a>	Provides information to install, make connections, operate, and troubleshoot the 6181P integrated display and non-display computers with solid-state drives.
Industrial Computers for Hazardous Locations User Manual, publication <a href="#">6181X-UM001</a>	Provides information and guidelines to install, make connections, operate, and troubleshoot the 6181X integrated display and non-display computers in hazardous locations and extreme temperature environments.
Non-display Industrial Computers User Manual, publication <a href="#">6177R-UM002</a>	Provides information to install, make connections, operate, and troubleshoot the 750R and 1450R non-display industrial computers.
VersaView 5100 Industrial Monitors User Manual, publication <a href="#">6200M-UM001</a>	Provides information to install, mount, and troubleshoot VersaView 5100 industrial monitors.
6186M Performance Monitors User Manual, publication <a href="#">6186M-UM002</a>	Provides information to install and mount the monitors, configure video setup, and troubleshoot the 6186M monitors.
6176M Standard Monitors User Manual, publication <a href="#">6176M-UM001</a>	Provides information to install and mount the monitors, configure video setup, and troubleshoot the 6176M monitors.
Product Certifications website, <a href="http://rok.auto/certifications">rok.auto/certifications</a>	Provides declarations of conformity, certificates, and other certification details.
ROK Automation YouTube site, <a href="https://www.youtube.com/user/ROKAutomation">https://www.youtube.com/user/ROKAutomation</a>	Provides informative videos on Rockwell Automation industrial computers and monitors, ThinManager software, and Rockwell Automation software.

You can view or download publications at <https://www.rockwellautomation.com/global/literature-library/overview.page>.

# Rockwell Automation Support

Use the following resources to access support information.

<b>Technical Support Center</b>	Knowledgebase Articles, How-to Videos, FAQs, Chat, User Forums, and Product Notification Updates.	<a href="http://www.rockwellautomation.com/knowledgebase">www.rockwellautomation.com/knowledgebase</a>
<b>Local Technical Support Phone Numbers</b>	Locate the phone number for your country.	<a href="http://www.rockwellautomation.com/global/support/get-support-now.page">www.rockwellautomation.com/global/support/get-support-now.page</a>
<b>Direct Dial Codes</b>	Find the Direct Dial Code for your product. Use the code to route your call directly to a technical support engineer.	<a href="http://www.rockwellautomation.com/global/support/direct-dial.page">www.rockwellautomation.com/global/support/direct-dial.page</a>
<b>Literature Library</b>	Installation Instructions, Manuals, Brochures, and Technical Data.	<a href="http://www.rockwellautomation.com/literature">www.rockwellautomation.com/literature</a>
<b>Product Compatibility and Download Center (PCDC)</b>	Get help determining how products interact, check features and capabilities, and find associated firmware.	<a href="http://www.rockwellautomation.com/global/support/pcdc.page">www.rockwellautomation.com/global/support/pcdc.page</a>

## Documentation Feedback

Your comments will help us serve your documentation needs better. If you have any suggestions on how to improve this document, complete the How Are We Doing? form at [http://literature.rockwellautomation.com/idc/groups/literature/documents/du/ra-du002\\_-en-e.pdf](http://literature.rockwellautomation.com/idc/groups/literature/documents/du/ra-du002_-en-e.pdf).

Rockwell Automation maintains current product environmental information on its website at <http://www.rockwellautomation.com/rockwellautomation/about-us/sustainability-ethics/product-environmental-compliance.page>.

Allen-Bradley, FactoryTalk, Integrated Architecture, LISTEN. THINK. SOLVE., PanelBuilder, PanelView, Rockwell Automation, Rockwell Software, RSLinx, RSView, Studio 5000, ThinManager, and VersaView are trademarks of Rockwell Automation, Inc.

Intel Atom, Intel Core, and Intel Xeon are trademarks of Intel Corporation.

Microsoft and Windows are trademarks of Microsoft Corporation.

PS/2 is a trademark of IBM Corporation.

SD is a trademark of SD-3C LLC.

VESA is a trademark of the Video Electronics Standards Association.

Rockwell Otomasyon Ticaret A.Ş., Kar Plaza İş Merkezi E Blok Kat:6 34752 İçerenköy, İstanbul, Tel: +90 (216) 5698400

**[www.rockwellautomation.com](http://www.rockwellautomation.com)**

### Power, Control and Information Solutions Headquarters

Americas: Rockwell Automation, 1201 South Second Street, Milwaukee, WI 53204-2496 USA, Tel: (1) 414.382.2000, Fax: (1) 414.382.4444

Europe/Middle East/Africa: Rockwell Automation NV, Pegasus Park, De Kleetlaan 12a, 1831 Diegem, Belgium, Tel: (32) 2 663 0600, Fax: (32) 2 663 0640

Asia Pacific: Rockwell Automation, Level 14, Core F, Cyberport 3, 100 Cyberport Road, Hong Kong, Tel: (852) 2887 4788, Fax: (852) 2508 1846

Publication IC-TD001L-EN-P - March 2020

Supersedes Publication IC-TD001K-EN-P - April 2019

Copyright © 2020 Rockwell Automation, Inc. All rights reserved. Printed in the U.S.A.